

32
Year
EDITION
ANNIVERSARY

GOLDLINE[®]
The New Age Bath Fittings



FAUCETS
ACCESSORIES
SHOWERS

CREATING A FIZZ,
THE STYLE

1st JANUARY **2026**

Manufacturing Process

In Goldline, we do R&D as a continuing process to improve product Concepts and functionality .It makes our products best in its class combined with trouble free technological superiority. Our products are crafted with customer centric focus on Quality Standards and ergonomically designed. You will not only get quality products but best after sales service.

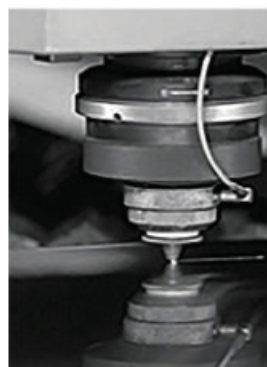
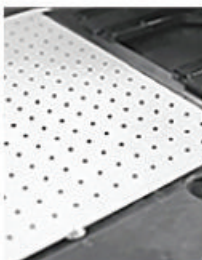

- Complete in-house production
- Biggest manufacturing facility in Delhi/NCR.
- Latest technology adopted to manufacture.
- Zero defect bath fittings.
- Biggest range of products.



Unmatched Warranty



GOLDLINE

The New Age Bath Fittings

About Us

PREMIUM SYSTEMS a Pioneer in bath fittings was established in 1994 by Shri Sanjeev Gupta, a technocrat from DELHI COLLEGE OF ENGINEERING. He introduced **GOLDLINE** brand of in Bath fittings. In the last 31 years **GOLDLINE** has established credibility in terms of Quality, competitive Pricing, on time Delivery, widest Range, exquisite Designs, all these backed up with excellent after sales Service. We have been constantly working on each of these parameters continuously, keeping in view customer requirements and satisfaction.

JOURNEY : Started in 1994 with a vision to create zero defect bath fittings and with a mission to make best Quality bath fitting with modern design and aesthetic looks at a competitive price suiting every buyer of varying financial prowess of our great country. We started with Delhi market but now **GOLDLINE** products are available in entire length & breadth of India and also we are exporting to SRILANKA and GULF countries.

 **Marked
BIS Approved**



ISCN-11
₹ 1340/-



ISCN-22
₹ 1340/-



ISCN-21
₹ 1210/-



ISCN-27
₹ 1210/-

PRODUCT RANGE :

- i) C.P. Fittings: In **GOLDLINE** we are proud to say that we have more than 50 designs and our most popular series since 2023 is PRIMEX. Now, we have added New Series **ALASKA & OPUS** in 2025. This shows our constant endeavour to introduce new designs & technology. We have also introduced Complete range of Sensor Taps in 2025. Our art & style is very popular, this proves that we have constantly been taking care of customer taste & choice with stringent quality checks.
 - ii) **GOLDLINE** can very proudly say that it has got all type of products like Showers, Health Faucets, Accessories, Stainless Steel Sinks, PVC Cistern, Sanitaryware, PTMT Taps & Sensor Taps.
 - iii) We have Single Lever exclusive ranges for high-end customers as well as economical ranges to suit each & every pocket.
 - iv) We have forged body Diverters in high flow and Basin Diverters.
- And all this are In-House production under one roof.

WHY YOU CHOOSE BLUES ?

Every **GOLDLINE** product passes through set quality standards at every stage before it is packed to be delivered to the valuable customers.

We follow BIS standards to make sure each & every faucet is tested to perform years after years.

We ensure :

- i) Brass composition: We have spectro machine to ensure the copper Percentage in our faucet is 56-59% . accurate.
- ii) All Rubber washers are of synthetic material and their shore hardness and tensile strength are tested as per BIS standards.
- iii) All screws used are SS304 quality.
- iv) Nickel and Chrome coating Ni > 10 microns and CR > 0.3 microns also we are doing 450 hrs salt spray test, To ensure corrosion resistance & long life of Nickel and chrome and a shiny and smooth surface.
- v) Testing : Each and every brass fitting is tested for 5.0 lac cycles at 5-7 bar water pressure to ensure there is no leakage and every faucet we produce has a stamp of **GOLDLINE** quality.
- vi) Even we have set standards for corrugated boxes to ensure that each and every product reaches safely to its destination.

CERTIFICATION :

BIS, ISO 9001:2015 Certified.

PROMPT SERVICE ON-SITE :

We have well trained team of Technicians who provides prompt & satisfactory service on-site.

Distribution Network



WHY YOU CHOOSE GOLDLINE ?

Every GOLDLINE product passes through set quality standards at every stage before it is packed to be delivered to the valuable customers. We follow BIS standards to make sure each & every faucet is tested to perform years after years.

We ensure :

- i) Brass composition: Copper 56-59% in our raw material as well as finished products.
- ii) All Rubber washers are of synthetic material and their shore hardness and tensile strength are tested as per BIS standards.
- iii) All screws used are SS304 quality.
- iv) Nickel and Chrome coating Ni > 10 microns and CR > 0.3 microns also we are doing 450 hrs salt spray test, To ensure corrosion resistance & long life of Nickel and chrome and a shiny and smooth surface.
- v) Testing : Each and every brass fitting is tested for 5.0 lac cycles at 5-7 bar water pressure to ensure there is no leakage and every faucet we produce has a stamp of GOLDLINE quality.
- vi) Even we have set standards for corrugated boxes to ensure that each and every product reaches safely to its destination.

PROMPT SERVICE ON-SITE :

We have well trained team of Technicians who provides prompt & satisfactory service on-site for concealed items.

WARRANTY :

32 Years of customer satisfaction & love. Unmatched warranty of upto 10 years (Condition apply). For more details read the warranty card. GOLDLINE products are available Pan India.

This makes GOLDLINE Products number one choice for everyone.



Unmatched Warranty



GOLDLINE

The New Age Bath Fittings

FAUCETS TECHNOLOGIES

Goldline introduced advanced technologies, and thanks to more than 32 years of accumulation of technology, Goldline's products are easy to use, stable in quality, and efficient in energy. We focus in comfortable use, and at the same time take into consideration of the water-saving and environment protection. Each Goldline production represents the perfect combination of technology, quality and design.

Qualified brass material

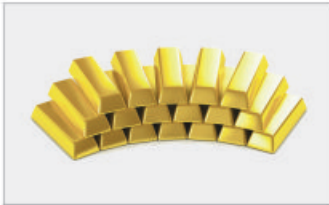

Using high-class brass material to ensure the health of water using from source.

Water saving design



Using air injection technique to make water flow be plentiful and lively, improve utilization of water.

Advanced surface finish process



After accurate milling, and full automatic polishing, the cast surface will be with clear outline to show the product design well.

Low pressure casting

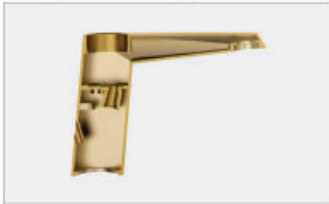

Adopting the advanced low pressure casting technology can avoid the possibility of air and impurity entrance. The casting will be with high density and fewer defects, which can ensure the durability of products.

Shinning plating technology

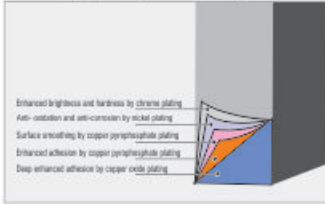

Double nanoscale plating finish with high hardness, good corrosion resistance and excellent abrasion resistance, is bright as mirror and enduring as time goes by.

Qualified valve



Superior ceramic cartridge with natural alumina ceramic chip, which attains Mohs rigidity level 9, just less than that of diamond (level 10) and with the advantage of high pressure temperature resistance, good abrasion resistance, stable chemical property, excellent anti-leakage capability and smooth switch. The life cycle of our cartridges is up to 500,000 cycles.

Fast installation structure



Using long barrel and large nut as installation components of faucets, make it convenient and fast to install the faucets firmly without any tools.

CNC machining

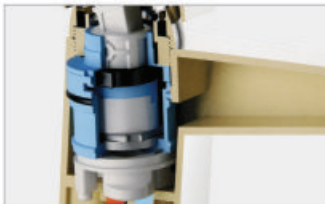

The faucets are machined by CNC machine, with accurate and stable dimension, to ensure the stability of assembly and avoid the product leaking.

milestone

2025
Juni 11

2022

A huge milestone achieved by Goldline as the company expanded by more than 200 employees.

Setting up a state-of-the-art manufacturing unit to go on stream by 13th April 2025, which will be approx. 4000 sq mtrs and 1.50 lac sq. ft. covered area with 500 employees.

2010

Launched 2nd manufacturing unit in Noida Sector 63 which was approx. 1000 Sq Meters and with 100 employees.

2000

Established the first manufacturing unit in Patparganj Industrial Area which was approximately 367sq meters with 30 employees.

1997

Premium System was launched with 15 workers and 1 concept "Queen Collection"

1994

The journey started with 1 employee with trading of bathroom fittings.



D Y PATIL INTERNATIONAL UNIVERSITY

AKURDI, PUNE

Established under Maharashtra Act No. LXIII of 2017
Sector 29, Pradhikaran, Akurdi Pune (Maharashtra) India 411044.

Ref. No. : DYPIU/

Date : 24/07/2025

TO WHOM IT MAY CONCERN

Name of project	D.Y.Patil Hostel Project (D.Y.Patil International University,Pune)
Nature of work	Supply of CP Fitting & Sanitary Items Make "Blues"
Name Of Agency	SHAH MULTILAYER PVT.LTD
GST Number	09AACCS3738G1Z9
Purchase Order Number	1) PO/DYPIU/SEP-2024/0078 2) PO/DYPIU/NOV-2024/HOSTEL-13

This is to inform you that the "BULES" CP & Sanitary items have been supplied to D.Y.Patil Hostel Project Under D Y Patil International University ,Sector 29, Nigdi Pradhikaran, Akurdi, Pune All the fittings and sanitary items installed has been functioning very well and we're pleased with the quality of the products.

We are delighted with the service provided and the performance of the installed bathroom fittings and sanitary ware and have also received commendable service support for the installation and the after sales service too.

Thanking Your

Registrar 24/7/25

Vice-Chancellor 24/7/25

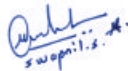
swarni.s.



Hon. Trustee

Development of Leisure Park Phase-III Residential Apartment at Plot No. GH 01 Sector - TCC Zone-IV, Greater Noida (UP) on Design, Engineering, Procurement and Construction (EPC) basis with comprehensive Operation & Maintenance of 02 Years
List of Approved Make:

LIST OF APPROVED MAKE: PLUMBING & SANITARY SECTION - 4

No.	MATERIAL	MAKES
1.	Sanitary fittings and accessories	Kohler, Jaquar, Ceatils, TOTO, Queo, Roca, Cadillan
2.	WC Seat covers (Heavy Duty)	Kohler, Jaquar, Ceatils, TOTO, Queo, Roca, Cadillan
3.	C.P brass fittings & Bathroom Accessories	Kohler, Jaquar, Ceatils, TOTO, Queo, Roca, Cadillan
4.	G.I., M.S Pipe	TKS, Jindal, Harsco, Surjo Prabhat, SAIL, APL Apollo
5.	G.I. Fittings	Unik, KS, Zuko, S-Formal, Surjo, Nam, TWC, Leader, Zoloto, KSB
6.	Roof Valve	Kohler, Jaquar, Ceatils, TOTO, Queo, Roca
7.	Automatic Flushing Cistern	ELIMEX, Wells, Pyure
8.	Air Disinfectant Unit (Valves)	Euronics, Vibacore, Jacuar
9.	Automatic Liquid Soap Dispenser near the door	Mcabino, Whitford, Carbochim
10.	Food crusher	AO-Smith, Jaquar, Beacoli, Havells, Bajaj
11.	Electrical Water Heater	Jayne, Neelkanti, Mirali, Croo, Alect
12.	Stainless Steel Sink	Grilly, Corbin, Jayra
13.	C.P. Grating	GNGL, Heer, Cully
14.	Cast Brass Chain Out P	Honeywell, WIP, DDP, SIKS
15.	GM Ball Valve	Honeywell, WIP, DDP, SIKS
16.	GM Wheel Valve	Honeywell, WIP, DDP, SIKS
17.	Pressure Reducing, balancing Valves	Karbhani, Aquapress, Umpro
18.	TRIP	Honeywell, WIP, DDP, SIKS
19.	C.I. Non-return valve (Dual Pipe type)	Neeco, Kapilatan Neel, Karar, Electro Ropy
20.	C.I. Pipes, fittings (U.S. 1989-1994)	Naco, Kapilatan, Neel, Kantar, Electro Ropy
21.	C.I. Pipe, fittings (Indians)	RE-NU, Greendorf, Polobest
22.	Polypropylene	WAL, Hyundai, Ion, Luxhange, volter
23.	Water Cooler with RO	Wipac, Aco, Sushma, Prince, ALC, APL, Apollo
24.	UPVC pipes, fittings	Prince Aetna, Supreme, Prince, AMS, APL, Apollo, Sudhakar, Surjo Prabhat
25.	CPVC pipes and fittings	NECO, SKF, Hapco, RPNF, RUF
26.	Centrifugally Cast (Steel) Iron Pipes & Fittings	NEC, Hapco, IATA
27.	Centrifugally Cast (Stainless) Iron Pipes & Fittings	NECO, Jindal, Harsco, Vallaga, RUF
28.	Centrifugally Cast (Steel) Ductile Iron Pipes & Fittings	

Page 12 of 28
Signature of Contractor
NECC
Digitally signed by ANUJ
Date: 2024.10.15 15:20:41 IST



STATE TREASURY
GOVERNMENT OF INDIA
MINISTRY OF RAILWAYS
IN CHARGE, NEW DELHI
RAIL COACH FACTORY, KAPURTHALA

CERTIFICATE OF REGISTRATION

In reference to above, Registration of your firm with this Organization is hereby as per following details:-
M/S SHRI MULTILAYER PVT. LTD., REGISTERED & WORKS ADDRESS : D-56, SECTOR 63,INDIRA-GARDIAN BUIDHA NAGAR, TIKRI PRADHAN - 201301, is hereby registered with Rail Coach Factory, Kapurthala on Provisional basis for Two years and monetary limit up to Rs.3.23 Cr. only (Rs to IN THIRTY POINT TWO THREE Cr only) for the following trade group:

Trade Group	Item Details
4318	VALVES AND COCKS OF SORTS AND SIZES.
This registration will remain valid up to: 30-06-2027	
Registration No.	M-2430
Date of Issue	01.07.2015
Applicant reference no.	Nil
	Dated: 04.11.2015

By: **CHAMUSHELL**
RCF Kapurthala

- Conditions of Registration:**
- Any change in constitution (Address, Partnership deed, Memorandum, Article of Association etc.) of your firm should be promptly communicated to this office.
 - Registration fee does not entitle you for getting tender enquiries in all cases and does not guarantee participation in award of Contract.
 - Registration No. allotted to you should be quoted in all future correspondence with this office. This registration will not apply to any of your other branch office.
 - You should apply for renewal of registration at least 3 months before expiry of validity along with following documents for this purpose.
 - Details of tenders of RCF in which you have participated
 - Certified / Audited copies of financial statements (Balance sheet - Profit & Loss Account - Annual Report) of last 3 years.
 - You shall abide by RCF condition of contract and other rules of Railway administration as in force at present and be extended from time to time.
 - RCF reserves the right to De-register / Renew or Suspend your firm without giving any notice whatsoever.
 - Any movement of your firm in contract practices (such as Private Management, Contract formation etc.) will tantamount to automatic De-registration.
 - Placement of order of this firm.
 - Your question in power to letters (other than trade group mentioned in this certificate) will be treated at par with unregistered vendors.
 - You should ensure availability of Digital Signature Certificate for participation in a tender of our Organization (ref: www.railways.gov.in)

Scan this QR code to instantly verify the authenticity of this certificate
Or follow the RCF website: cf.mumbai.gov.in



Address for Communication:
PCMA Office, Administrative Building
Rail Coach Factory, Kapurthala (Punjab) Pin-144602
Telephone: 01823-27754 / Fax: 01823-228980
Website: www.railways.gov.in
E-mail: rcf@railways.gov.in
Tender Site: 1981 30006.2003.0002.018

OUR CERTIFICATES

PANCHAMI LAHA
GOVT. CONTRACTOR & SUPPLIER
Address: Ground floor, House no -89, Swarn Jyanti Vihar,
Block C4, Tikra Khurd JJ, Colony Delhi-110060

Mobile No: 9988512228
Date: 02/02/2024

Performance Certificate

Name of Work:	A/R & M/o Hostel 1 to 19 & allied areas (SH: Supply of material for day to day maintenance items in Gents Hostel 1 to 8) at AIIMS.
Agency Name :	Smt. Panchami Laha
Agreement No:	188/B&R/CD-1/2023-24

We are pleased to inform that "Goldline" Faucets and Sanitaryware have been supplied by you have been installed at AIIMS hospital located in Delhi and has been functioning very well.

We are delighted with the service and the performance of the installed bathroom fittings and have got commendable service support for the installation and after sales service too.

Panchami Laha
For PANCHAMI LAHA
Proprietor

HITES
HLL INFRA TECH SERVICES LTD

15.05.2024

HITES/DIR/CA/02024-25/146

To,
Premium Systems,
250, PLE Postnagar Industrial Area
Delhi - 110029.

Subj: Approved Make List for Product Approval of GOLDLINE for projects under HITES.

Ref: Letter dated 26.04.2024

Following product manufactured by Premium Systems has been included in the List of approved makes for the works under the HLL Infra Tech services Ltd.

Sr. No.	CMV/Pumbing Works	Remarks
1.	PTMR & CP Brass Fittings	Plumbing, Bath & Sanitary Items.

Conditions:

- The approval for inclusion in the preferred make list of HITES has been given on the specific request of the company. It is purely the discretion of HITES approval authority to include or exclude the approved product in the list. It is the responsibility of field officers. The field officers are requested to ensure the product brought at site / proposed to be used for work is as per approval / bid document specifications. In case if the product is not as per bid document specifications the same should be recommended to this office for amendment of approval.
- The approval will be cancelled if material does not conform to ISH-4000 quality standard as per / or as per the specification of the product as per the bid document.
- Material received will also be announced at any time if it is found that the information submitted to this office is incorrect.
- This approval shall not make the firm eligible for claiming the right to get the work done / items procured through them only. The work procurement is subject to HITES competitive offers against similar competing manufacturers, brands supplied by this approval without assigning any Q3320.
- The department reserves the right to amend this approval without assigning any Q3320.

This issues with the approval of Competent Authority.

Authorized Signatory
[Signature]
HITES, Noida - 201302

CC 1. VP (D)-South
2. VP (D)-North

HLL Infra Tech Services Ltd
B-Block, C-18, Liberty St,
Sector-16, Gurgaon, Haryana
Corporate Office: 3rd Floor, Sector-22,
Noida-201301, Uttar Pradesh
For more information contact
Vishal Verma at 9810011111
or 011-26100111
Email: sales@hitesinfra.com

Request for the within table approval from the field officers at project sites under the HITES
Name of the Project
Approved make list for work
For more information contact
Vishal Verma at 9810011111
or 011-26100111
Email: sales@hitesinfra.com

OUR CERTIFICATES



CERTIFICATE

ZED BRONZE

under MSME Sustainable (ZED) Certification Scheme
awarded to

SHAH MULTILAYER PRIVATE LIMITED

UNIT NAME

Flat No.- D-56, Building:- SHAH MULTILAYER PVT LTD, Road/Street, SECTOR - 63,
Villager town:- D BLOCK, Block:- 1, UTAHMI BUDDHA ANGAK, UTAHAR
PRADESH-201301

UNIT ADDRESS

**26-Manufacture of fabricated metal products, except machinery and
equipment**

CODE (ASPERNIC-23EN)
UDYAM-DL-02-0007691

USTAD REGISTRATION NUMBER



Certificate No. : 2002023_212374

Valid till:
July 25, 2023
(Certificate Validity)
Three years from the date of issue.

The Certificate has been awarded after fulfilling all relevant requirements as laid down in the
Award of this Certificate does not substitute any legal requirement needed for setting up or operating an MSME Unit.



सर्वोच्च न्यायालय द्वारा प्रमाणित
MINISTRY OF
MICRO, SMALL &
MEDIUM ENTERPRISES



GAURS
group own world

Date: - 05/08/2024

TO WHOM IT MAY CONCERN

Name of Project	Gaur Agro City
Nature of Work	Supply of CP Fitting & Sanitary Items Maker = "BLUES"
Name of Agency	SHAH MULTILAYER PVT. LTD.
GST Number	09AACCS3786GT29
Purchase Order Number	EWSPOIND/00085/24-25, EWSPOIND/00270/23-24, EWSPOIND/00236/23-24,

This is to inform you that the "BLUES" CP & Sanitary Items have been supplied to Gaur Agro City, Pocket-02 at Ajantapuram Lond Road, Chazalabad, Uttar Pradesh. All the fittings and sanitary items installed has been functioning very well and we're pleased with the quality of the products.

We are delighted with the service provided and the performance of the installed bathroom fittings and sanitary ware and have also received commendable service support for the installation and the after sales service too.

Thanking you

For

Authorized Signatory

UP Township Infrastructure Private Limited



UP TOWNSHIP INFRASTRUCTURE PRIVATE LIMITED
Gaur Agro Heights
Plot No. 102, 1st Phase, Azadi Colony, Gaur City, Sector 203, Dist. Meerut (Uttar Pradesh), India
Corporate Office: Gaur Agro Heights, Plot No. 1, Ashby Road (I), Ashby Colony, Ghazalabad - 201418 (UP) India
Tel: 011-826-494-3333 | Email: info@gaurs.com | Website: www.gaurs.com

OUR CERTIFICATES



GLIBS CONSTRUCTION
CIVIL ENGINEER & GOVT. CONTRACTOR
Address: 1P-117 second floor manjara circle,
Pimpri, Pune, India: 411064
Phone: (91) 9893415351, 9873220923
Email id: mhehd35@gmail.com

DATE: 07/08/24

CERTIFICATE

NAME OF WORK: PROVISION OF ADDITION / ALTERATION AND SPECIAL REPAIR OF AKSHITA BUILDING AT KAMATH ENCLAVE, SECTOR -52 NOIDA.

CANO: CECCG/GOA/23 OF 2023-24

IT IS INFORMED TO YOU THAT THE BLUE'S CP & SANITARY ITEMS HAVE BEEN SUPPLIED BY YOU AND HAVE BEEN INSTALLED IN KAMATH ENCLAVE INDIAN COAST GURD SEC 52 NOIDA UNDER (MILITARY ENGINEER SERVICES) AND HAS BEEN WORKING IN GOOD CONDITION.

WE ARE ALSO DELIGHTED WITH THE SUPPORT SERVICES PROVIDED BY BLUE'S BATH FITTING.

For GLIBS CONSTRUCTION

Partner



Date: 04/08/2024

Performance Certificate

Name of Work: - Upgradation and Expansion of Shri Vardha Shree Care Hospital at Silvassa to Multi - Specialty Hospital (Auxiliary Building & Site Development).

Name of Agency: - Shanti Precon LLP.

Work Order No. - Letter of your Office 4-1090/PGT-E-TENDER/2019 - 20/363 /

Dated 16.06.22

It is informed to you that the "BLUES" CP & Sanitary Items have been Supplied by you and have been installed in Shri Vardha Shree Care Hospital at Silvassa and has been functioning very well.

We are delighted with the service and the performance of the received bath room and toilet fittings and have got commendable service support for the installation and after sales service too.

Yours Faithfully,

For, Shanti Precon LLP

Authorized Signatory

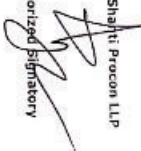



OUR CERTIFICATES

What's your Style?

Whatever your style preference, **Goldline** offers a wide range of contemporary and traditional designs to help you create your perfect bathroom.



FAUCETS INDEX

S.NO.	RANGE NAME	COLOUR	FITTING INTERNAL	PAGE NO.	RANGE CODE
1	AUTOMATIC SENSOR	-	-	01-02	SF
2	URINAL SENSOR	-	-	03	SF
3	SENSOR TAP	-	-	04-06	SF
4	TISSUE PAPER DISPENSER	-	-	07-08	SF
5	AUTOMATIC SOAP DISPENSER	-	-	09	SF
6	HAND DRYER	-	-	10	SF
7	OPUS	CHROME	15mm	11-12	OU
8	ALASKA	CHROME	15mm	13	AK
9	BLOOM	CHROME	15mm	14	BO
10	EVION	CHROME	15mm	15	EV
11	VIVO	CHROME	15mm	16	VO
12	IMPERIAL	CHROME	15mm	17	IM
13	PRIME	MATT BLACK GOLD	15mm	18	PR-MATBG
13A	PRIME	ROSE GOLD	15mm	19	PR-RG
13B	PRIME	GOLD	15mm	20	PR-FG
13C	PRIME	BLACK	15mm	21	PR-BL
13D	PRIME	MATT BLACK	15mm	22	PR-MB
13E	PRIME	METALLIC BLACK	15mm	23	PR-MBTB
13F	PRIME	CHROME GOLD	15mm	24	PR-CG
13G	PRIME	CHROME	15mm	25-28	PR
14	TREND	CHROME	15mm	29	TR
15	NEO	CHROME	15mm	30	NO
16	CRAFT	CHROME	15mm	31	CF
17	ECO-SERIES	CHROME	15mm	32	ES
18	Z-SERIES	CHROME	15mm	33	ZS
19	LEXUS	CHROME	15mm	34	LX
20	CONTINENTAL	CHROME	15mm	35	CN
21	AXIS	CHROME	15mm	36	AX

S.NO.	RANGE NAME	COLOUR	FITTING INTERNAL	PAGE NO.	RANGE CODE
22	CUBIX	CHROME	15mm	37	CB
23	ASDA	CHROME	15mm	37	AA
23A	ASDA	METALLIC BLACK	15mm	39	AA-MB
24	CLASSIC ARTISTO	CHROME	15mm	40	CAR
25	CLASSIC AMARA	CHROME	15mm	41	CAM
26	FLORENTINE	CHROME	20mm	42	FL
26A	FLORENTINE-B	CHROME	20mm	43	FL-MATB
27	FUSION PLUS	CHROME	20mm	44	FP
28	CARDIFF	CHROME	15mm	45	CA
29	EVOKE	CHROME	15mm	46	EV
30	ROVER	CHROME	15mm	47	RO
31	CLASSIC VIBRO	CHROME	15mm	48	CVB
32	OPAL PRIME	CHROME	15mm	49	OPP
33	ALIVE	CHROME	15mm	50	AV
34	TOUCH	CHROME	15mm	51	TO
35	NECTAR	CHROME	15mm	52	NE
36	FRANC	CHROME	15mm	53	FC
37	AESTRIX	CHROME	15mm	54	AS
38	ADVENT	CHROME	15mm	55	AD
39	ARIA	CHROME	15mm	56	AT
39A	ARIA	ROSE GOLD	15mm	57	AT-RG
39B	ARIA	BLACK	15mm	58	AT-BL
39C	ARIA	CHROME GOLD	15mm	59	AT-CG
39D	ARIA	GOLD	15mm	60	AT-FG
40	CONTI PROJECT	CHROME	15mm	61	CP
41	ELITE	CHROME	15mm	62	EL
42	IIFA	CHROME	15mm	63	II
43	EURO	CHROME	15mm	64	EU

44	COSMOS	CHROME	15mm	65	CS
45	CARO	CHROME	15mm	66	CR
46	BLEND	CHROME	15mm	67	BL
47	VIGNET	CHROME	20mm	68	VI
48	FENDI	CHROME	15mm	69	FN
49	CITY	CHROME	15mm	70	CT
50	VEGAS	CHROME	15mm	71	VG
51	ALFA	CHROME	15mm	72	AF
52	ORNO	CHROME	15mm	73	OR

BATH ACCESSORIES

S.NO.	RANGE NAME	COLOUR	PAGE NO.	RANGE CODE
53	ANGEL	CHROME	75	1000
54	DIAMOND	CHROME	76	1100
55	METALLIC BLACK	METALLIC BLACK	77	1400
56	MATRIX	ROSE GOLD	78	1200
57	PLATINUM	GOLD	79	1300
58	SIGNATURE	CHROME	80	4000
59	QUADRA	CHROME	81	QA
60	DOOM	CHROME	81	DM
61	PRIME	CHROME	82	PE
62	AMARA	CHROME	82	AA

BATH ACCESSORIES

S.NO.	RANGE NAME	COLOUR	PAGE NO.	RANGE CODE
63	TOWEL RODS	CHROME	83	TR
64	TOWEL RACK	CHROME	83	TK
65	TOWEL RING	CHROME	83	TG

SHOWERS

S.NO.	RANGE NAME	COLOUR	PAGE NO.	RANGE CODE
66	SANDWICH	CHROME	84	SHSW
66	ULTRA SLIM	CHROME	84	SHUS
66	ELEGANCE	CHROME	84	SHEN
66	KOLLER	CHROME	84	SHKO
66	CURVE	S.S.	84	SHCV

67-68	OVERHEAD SHOWER	CHROME	85-86	OHS
69	OVERHEAD SHOWER	PVD	86	SHEN
69	TELEPHONE SHOWER	PVD	87	TS
69	HEALTH FAUCETS	PVD	87	HF

HEALTH FAUCETS/TEL. SHOWERS

S.NO.	RANGE NAME	COLOUR	PAGE NO.	RANGE CODE
70	HEALTH FAUCETS	ABS	87	HF
70	HEALTH FAUCETS	BRASS	87	HFB
70	TELEPHONE SHOWER	CHROME	87	TS
70	SHOWER ARM	S. S.	87-88	SA

ALLIEDS

S.NO.	RANGE NAME	COLOUR	PAGE NO.	RANGE CODE
71	MOUTH OPERATED TAPS	CHROME	89	FO
71	BOTTLE TRAP	CHROME METALLIC BLACK	89	BT
71	PRESSMATIC TAPS	CHROME	89	PT
71	ELBOW ACTION COCKS	CHROME	89	AL
71	TAP CLEANER	CHROME	89	
71	TEFLON TAP	CHROME	89	
71	SOAP DISPENSER	CHROME	89	SD
72	CONTROL COCKS	CHROME	90	CC
73	EXTENSION NIPPLE	CHROME	90	EXT
73	WASTE COUPLINGS	CHROME	90	WC
73	PROJECT ANGLE VALVE	CHROME	90	PAV
73	FLUSH VALVE	CHROME	90	FV
74	DIVERTER CONCEALED BODY	CHROME	91	DIV



Save Water



Smooth Flow



Maximum Comfort



Rich Quality



Long Lasting Smart Finish

Automatic Sensor



EXPERIENCE PREMIUM
BATHING WITH ADVANCED

SENSORS



SF-U205F (BRUSHED S.S.)



₹9240/-

Electrical Operated Concealed
Urinal Flusher 220V AC

Sensing Distance : 50-650mm

Flush Time : 8 Seconds Post-flush

Working Water Pressure : 0.02Mpa-0.8Mpa

Inlet/Outlet : G1/2" (Dn15)

Material : Screwless Front Plate SS with ABS frame, ABS Concealed Box, POM Solenoid Valve with Brass flow control

An ideal install & forget solution for sites with power backup as it consumes negligible power & runs excellently on generators & invertors

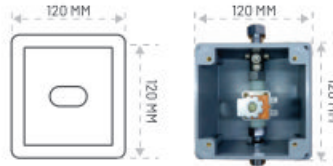

SF-U642S (SATIN SILVER)



₹9710/-

Battery Operated Concealed Urinal Flusher
6V DC - 4X AA Size Alkaline

Sensing Distance : 50-650mm

Flush Time : 8 Seconds Post-flush

Working Water Pressure : 0.02Mpa-0.8Mpa

Inlet/Outlet : G1/2" (Dn15)

Material : ABS Satin Finish Front Plate, ABS Concealed Box, PoM Solenoid Valve 'L' type with Brass flow control

Premium model with one of its kind aesthetic Urbane look 'Satin Finish' sensor plate

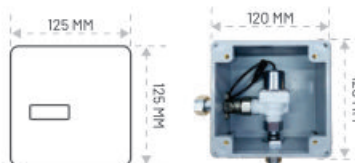

FLUSHBUOY (DC)



₹7920/-

Battery Operated Exposed Urinal Sensor
6V DC - 4X AA Size Alkaline

Sensing Distance : 50-650mm

Flush Time : 8 Seconds Post-flush

Working Water Pressure : 0.02Mpa-0.8Mpa

Inlet/Outlet : G1/2" (Dn15)

Cost-effective, ready-to-install model that automates existing manual flush systems with no need for civil work

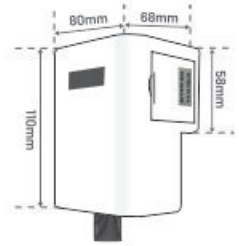

AVAILABLE COLORS :



SF-BRAVO

- In build Sensor
- High Quality Ceramic
- Easy Installation

₹18880/-



SF-CARO

- In build Sensor
- High Quality Ceramic
- Easy Installation

₹14240/-



Basin Mounted Mixer Sensor Faucet
Material : Chrome plated Brass Metal Body

Power : DC | AC | AC/DC (6V DC/220V AC)

Sensing Distance : 30-200mm

Safety Shut Off : 1 Minute

Working Water Pressure : 0.02Mpa-0.8Mpa

Inlet/ Outlet : G1/2" (Dn15)

Sleek, Hidden Mouth Sensor at Faucet
Opening for an Enhanced User Experience

SF-F297

₹9750/-

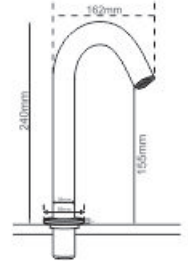

Basin Mounted Mixer Sensor Faucet
Material : Chrome plated ABS Plastic Body

Power : DC | AC | AC/DC (6V DC/220V AC)

Sensing Distance : 30-200mm

Safety Shut Off : 1 Minute

Working Water Pressure : 0.02Mpa-0.8Mpa

Inlet/ Outlet : G1/2" (Dn15)

Crafted from durable ABS, it offers sleek
aesthetics and reliable performance.

SF-F497

₹7820/-

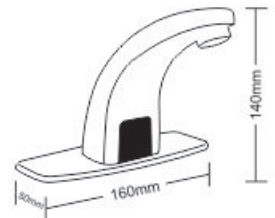

Basin Mounted Mixer Sensor Faucet
Material : Chrome plated Brass Metal Body

Power : DC | AC | AC/DC (6V DC/220V AC)

Sensing Distance : 30-200mm

Safety Shut Off : 1 Minute

Working Water Pressure : 0.02Mpa-0.8Mpa

Inlet/ Outlet : G1/2" (Dn15)

Ergonomically designed in swan neck with
Linear sensor, best fit for all sizes basin

SF-F067

₹10050/-

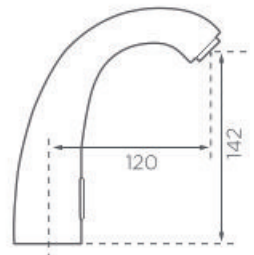

Wall Mounted Mouth Sensor Faucet
Material : Chrome plated Brass Metal Body

Power : DC | AC | AC/DC (6V DC/220V AC)

Sensing Distance : 30-150mm

Safety Shut Off : 1 Minute

Working Water Pressure : 0.02Mpa-0.8Mpa

Inlet/ Outlet : G1/2" (Dn15)

Sleek hidden mouth sensor at faucet opening for Great user experience

SF-F197
₹9340/-

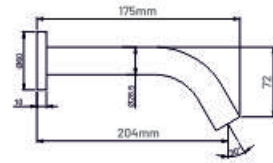

Wall Mounted Mouth Sensor Faucet
Material : Chrome plated Brass Metal Body

Power : DC | AC | AC/DC (6V DC/220V AC)

Sensing Distance : 30-150mm

Safety Shut Off : 1 Minute

Working Water Pressure : 0.02Mpa-0.8Mpa

Inlet/ Outlet : G1/2" (Dn15)

Sleek hidden mouth sensor at faucet opening for Great user experience

SF-F197
₹9340/-

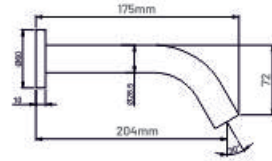

SF-TSA-621W



₹3205/-

Polycarbonate ABS Body
Multifold Tissue Paper Dispenser

Material : Polycarbonate ABS

Mounting Type : Wall Mount

Style : Modern Design

Capacity : Single Roll Wall Mount

Modern stylish Water proof shell keep paper dry in case of getting wet

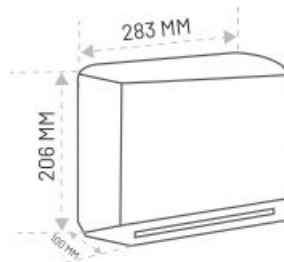

SF-TSA-62



₹5520/-

Stainless Steel
Tissue Paper Dispenser

Material : Stainless Steel Casing (304)

Mounting Type : Wall Mount

Paper Type : C-Folded, M-Folded

Capacity : 300-400 Tissues

The dispenser has a durable shell and is a long-lasting product. It is resistant against moisture and corrosion

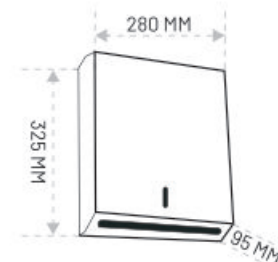

SF-ASA-105



₹6565/-

Battery Operated Automatic Soap Dispenser
6V DC - 4X AA Size Alkaline

Material : Polycarbonate ABS

Storage Capacity : 500ml

Sensing Range : 8-10cm

Dispenser Volume : 0-5ml

Lock the whole device by one key on action.
Rubber sealing on battery compartment prevent from
Splashing water into the device

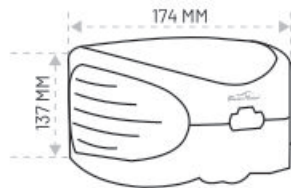

SF-HAS-222N



₹6800/-

Battery Operated Automatic Disinfecting
Soap/ Sanitizer Dispenser

Material : Polycarbonate ABS

Storage Capacity : 1000ml

Sensing Range : 8-10cm

Dispenser Volume : 2 ml

Power : 4 C-Type Battery or 6 volt 1 Amp DC Adapter

This automatic dispenser provides touch-free hygiene with a
1000ml capacity, ensuring efficiency and minimal waste

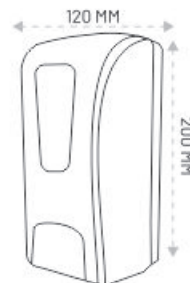

(AC/DC Adaptor on demand)

SF-HD-951B



₹19385/-

Polycarbonate ABS casing
Automatic Airblade Jet Hand Dryer

Material : Polycarbonate ABS

Rated Frequency : 50/60 Hz

Air Speed : 95 M/S

Auto Cut Off : 60 Second

Drying Time : 5-7 Second

Power Variable : 1200 W

Dimensions : W234 x D144 x H390

Power accurately reduce the flow of air to light machines, bringing more power

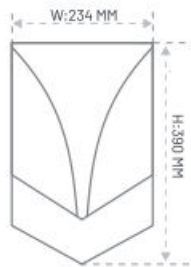

SF-HDS-612



₹20535/-

High speed Hand Dryer Energy
Efficient with a long life motor

Material : Stainless Steel 304 Grade

Rated Frequency : 220V AC

Noise Level : 75dB (at 2 meter)

Air Speed : 110 M/S

Auto Cut Off : 60 Second

Drying Time : < 5-7 Second

Power Variable : 1000W

The Mini powerful vertical shape ensures the hand dryer can be sited in narrower, smaller bathrooms where wall space is limited.

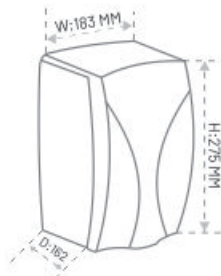



Highly attractive low cost
Stainless Steel Hand Dryer

Material : Stainless Steel 304 Grade
Rated Voltage : 220V AC
Rated Frequency : 50 / 60 Hz
Air Speed : 12 M/S
Auto Cut Off : 60 Second
Drying Time : 12 Second
Power Variable : 1500 W

Cost effective model in SS 304 body
Attractive & robust stainless steel body

SF-HDS-610

₹17150/-

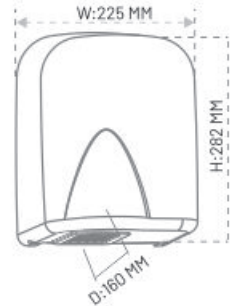

Highly attractive low cost
M.S. Body in SS Finish Hand Dryer

Material : M.S. Body in SS Finish
Rated Voltage : 220V AC
Rated Frequency : 50 / 60 Hz
Air Speed : 12 M/S
Auto Cut Off : 60 Second
Drying Time : 12 Second
Power Variable : 1800 W

Cost effective model in MS body
Attractive & robust stainless steel body

SF-HDM-304

₹12110/-

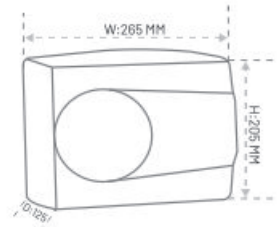

Basin Mounted Mixer Sensor Faucet
Material : Chrome plated Brass Metal Body

Power : DC | AC | AC/DC (6V DC/220V AC)
Sensing Distance : 30-200mm
Safety Shut Off : 1 Minute
Working Water Pressure : 0.02Mpa-0.8Mpa
Inlet/ Outlet : G1/2" (Dn15)

Ergonomically designed in swan neck with
Linear sensor, best fit for all sizes basin

SF-ASS-444

₹7720/-



OU-47
Single Lever Basin Mixer
₹ 4070/-



OU-48
Single Lever Basin Mixer 12" Long
₹ 5650/-



OU-41
3-in-1 Wall Mixer with L-Bend
₹ 6440/-



OU-40
Wall Mixer with L-Bend
₹ 5765/-

OU-17
Flush Cock 1" Medium
Forged Body & Fitting
₹ 810/-

OU-18
Upper Part of Flush Cock
(Light & Medium)
₹ 860/-

OU-19
Flush Cock (Heavy)
Body & Fitting
₹ 1800/-

OU-25
Upper Part of
Flush Cock (Heavy)
₹ 1145-

OU-16
Pillar Cock 12" Tall
₹ 2905/-



OU-11
Pillar Cock
₹ 1525/-



OU-21
Bib Cock
₹ 1125/-



OU-22
Long Nose
₹ 1255/-



OU-26
2-in-1 Bib Cock
₹ 1980/-



OU-27
Angle Valve
₹ 995/-



OU-29
2-in-1 Angle Valve
₹ 1980/-



Concealed Stop Cock
OU-31 - 15mm | ₹ 1525/-
OU-32 - 20mm | ₹ 1525/-



OU-23
Flush Cock 1" Medium Forged Body
₹ 1665/-



OU-24
Flush Cock 1" Heavy
₹ 2860/-



OU-14
Flush Cock 1" Light Casted Body
₹ 1665/-



OU-34
Sink Cock (J Spout)
₹ 1810/-



OU-35
Swan Neck (J Spout)
₹ 1980/-



Exposed Parts for Single Lever Diverter
OU-EXP-01 - 40mm (Normal) ₹ 1885/-
OU-EXP-05 - 45mm (Hi-Flow) ₹ 1885/-
OU-EXP-06 - 3-in-let (Hi-Flow) ₹ 2055/-



OU-61
Plain Spout
₹ 1300/-



OU-60
Tipton Spout
₹ 1810/-



OU-43
Sink Mixer
₹ 3730/-

Single Lever Diverter Complete
OU-56 - 40mm (Normal) ₹ 5880/-
OU-59 - 40mm (Hi-Flow) ₹ 6435/-
OU-45 - 45mm (Hi-Flow) ₹ 7215/-

OU-EXP-01-Exposed Parts for Diverter
(DIV-01,02,03,12,13) ₹ 1885/-
OU-42 Center Hole Quarter Turn
₹ 3955/-

OU-EXP-05-Exposed Parts for
Diverter (DIV-05) ₹ 1885/-
OU-EXP-06-Exposed Parts
for Diverter (DIV-06) ₹ 2055/-

Single Lever Diverter Body & Fitting
DIV01 - 40mm (Normal) • ₹ 3995/-
DIV02 - 40mm (Hi-Flow) • ₹ 4550/-
DIV05 - 45mm (Hi-Flow) • ₹ 5330/-
DIV03 - 40mm (Project) • ₹ 3390/-



AK-47
Single Lever Basin Mixer
₹ 4070/-



AK-40
Wall Mixer with L-Bend
₹ 5765/-



AK-48
Single Lever Basin Mixer 12" Tall
₹ 5650/-



AK-11
Pillar Cock
₹ 1525/-



AK-21
Bib Cock
₹ 1125/-



AK-22
Long Nose
₹ 1255/-



AK-26
2-in-1 Bib Cock
₹ 1980/-



AK-27
Angle Valve
₹ 995/-



Conc. Stop Cock (Fitting 15mm)
AK-31 - 15mm ₹ 1525/-
AK-32 - 20mm ₹ 1525/-



AK-14
Flush Cock 1" Light
Casted Body ₹ 1665/-



AK-24
Flush Cock 1" Heavy
₹ 2800/-



AK-60
Tip Ton Spout
₹ 1810/-



AK-61
Plain Spout
₹ 1300/-



S/L Diverter Complete
AK-56 - 40mm (Normal) ₹ 5880/-
AK-59 - 40mm (Hi-Flow) ₹ 6435/-
AK-45 - 45mm (Hi-Flow) ₹ 7215/-



AK-34
Sink Cock (J Spout)
₹ 1810/-



AK-35
Swan Neck (J. Spout)
₹ 1980/-



AK-16
Pillar Cock 12" Tall
₹ 2905/-



AK-43 Sink Mixer
₹ 3730/-

AK-23
Flush Cock 1" Medium Forged
Body ₹ 1665/-

AK-29
2-in-1 Angle Valve
₹ 1980/-

AK-41
3-in-1 Wall Mixer with Bend
₹ 6440/-

AK-42
Center Hole Quarter Turn
₹ 3955/-

AK-44
Non-Telephonic
₹ 3840/-



BO-42
Basin Mixer Quarter Turn
₹ 3165/-



BO-40
Wall Mixer with L-Bend
₹ 4150/-



BO-11
Pillar Cock
₹ 985/-



BO-21
Bib Cock
₹ 745/-



BO-22A
Long Body
₹ 850/-



BO-27
Angle Valve
₹ 485/-



BO-26
2-in-1 Bib Cock
₹ 1470/-



BO-29
2-in-1 Angle Valve
₹ 1580/-



BO-23
Flush Cock 1" Medium Forged Body
₹ 1600/-



Concealed Stop Cock (Fitting 15mm)
BO-31 - 15mm | ₹ 1245/-
BO-32 - 20mm | ₹ 1245/-



BO-14
Flush Cock 1" Light Casted Body
₹ 1600/-



BO-24
Flush Cock 1" Heavy
₹ 2800/-



BO-34
Sink Cock (J Spout)
₹ 1400/-



BO-43
Sink Mixer
₹ 3390/-



BO-35
Swan Neck (J Spout)
₹ 1515/-

BO-16
Pillar Cock 12" Tall
₹ 2905/-

BO-20
Nozzle Bib Code
₹ 930/-

BO-28
Washing Machine Tap
₹ 930/-

BO-41
3-in-1 Wall Mixer With Bend
₹ 5100/-



EV-42
Basin Mixer Quarter Turn
₹ 3165/-



EV-40
Wall Mixer with L-Bend
₹ 4150/-



EV-11
Pillar Cock
₹ 985/-



EV-21
Bib Cock
₹ 745/-



EV-22A
Long Body
₹ 850/-



EV-27
Angle Valve
₹ 485/-



EV-26
2-in-1 Bib Cock
₹ 1470/-



EV-29
2-in-1 Angle Valve
₹ 1580/-



EV-23
Flush Cock 1" Medium Forged Body
₹ 1600/-



Concealed Stop Cock (Fitting 15mm)
EV-31 - 15mm | ₹ 1245/-
EV-32 - 20mm | ₹ 1245/-



EV-14
Flush Cock 1" Light Casted Body
₹ 1600/-



EV-34
Sink Cock (J Spout)
₹ 1400/-



EV-43
Sink Mixer
₹ 3390/-



EV-35
Swan Neck (J Spout)
₹ 1515/-

EV-16
Pillar Cock 12" Tall
₹ 2905/-

EV-20
Nozzle Bib Code
₹ 930/-

EV-28
Wahing Machine Tap
₹ 930/-

EV-41
3 in 1 Wall Mixer With Bend
₹ 5100/-



VO-42
Center Hole Basin Mixer
₹ 3730/-



VO-40
Wall Mixer with L-Bend
₹ 5990/-



VO-41
3-in-1 Wall Mixer with L-Bend
₹ 7005/-



VO-11
Pillar Cock
₹ 1355/-



VO-27
Angle Valve
₹ 880/-



VO-26
2-in-1 Bib Cock
₹ 1945/-



VO-29
2-in-1 Angle Valve
₹ 1720/-



VO-20
Nozzle Bib Cock
₹ 1130/-



Concealed Stop Cock (Fitting 15mm)
VO-12 - 15mm | ₹ 1580/-
VO-12 - 20mm | ₹ 1580/-



VO-14
Flush Cock 1" Light Casted Body
₹ 1600/-



VO-23
Flush Cock 1" Medium Forged Body
₹ 1600/-



VO-24
Flush Cock 1" Heavy
₹ 2800/-



VO-35
Swan Neck (J Spout)
₹ 1910/-



VO-34
Sink Cock (J Spout)
₹ 1720/-



VO-43
Sink Mixer
₹ 4405/-

VO-21
Bib Cock
₹ 1030/-

VO-22A
Long Nose
₹ 1155/-

VO-16
Pillar Cock 12" Tall
₹ 2905/-

VO-44
Non-Telephonic
₹ 4520/-

VO-28
Washing Machine Tap
₹ 1130/-



IM-42
Center Hole Basin Mixer
₹ 3910/-



IM-40
Wall Mixer with L-Bend
₹ 6170/-



IM-41
3-in-1 Wall Mixer with L-Bend
₹ 7185/-



IM-11
Pillar Cock
₹ 1445/-



IM-27
Angle Valve
₹ 970/-



IM-26
2-in-1 Bib Cock
₹ 2125/-



IM-29
2-in-1 Angle Valve
₹ 1900/-



IM-20
Nozzle Bib Cock
₹ 1220/-



Concealed Stop Cock (Fitting 20mm)
IM-12 - 15mm | ₹ 1810/-
IM-12A - 20mm | ₹ 1840/-



IM-14
Flush Cock 1" Light Casted Body
₹ 1680/-



IM-23
Flush Cock 1" Medium Forged Body
₹ 1680/-



Concealed Stop Cock (Fitting 15mm)
IM-31 - 15mm | ₹ 1670/-
IM-32 - 20mm | ₹ 1670/-



IM-24
Flush Cock 1" Heavy
₹ 2860/-



IM-35
Swan Neck (J Spout)
₹ 2000/-



IM-34
Sink Cock (J Spout)
₹ 1810/-



IM-43
Sink Mixer
₹ 4590/-

IM-21
Bib Cock
₹ 1120/-

IM-22A
Long Nose
₹ 1245/-

IM-16
Pillar Cock 12" Tall
₹ 2995/-

IM-44
Non-Telephonic
₹ 4700/-

IM-28
Washing Machine Tap
₹ 1220/-



PR-MATBG-47
S/L/ Basin Mixer
₹ 5290/-



PR-MATBG-40
Wall Mixer with L-Bend
₹ 7505/-



PR-MATBG-41
3-in-1 Wall Mixer with Bend
₹ 8835/-



PR-MATBG-11
Pillar Cock
₹ 1850/-



PR-MATBG-21
Bib Cock
₹ 1420/-



PR-MATBG-22
Long Nose
₹ 1620/-



PR-MATBG-26
2-in-1 Bib Cock
₹ 2690/-



PR-MATBG-27
Angle Valve
₹ 1420/-



PR-MATBG-27
2-in-1 Angle Valve
₹ 2690/-



Concealed Stop Cock (Fitting 15mm)
PR-MATBG-31 - 15mm • ₹ 2020/-
PR-MATBG-32 - 20mm • ₹ 2065/-



PR-MATBG-24
Flush Cock 1" Heavy
₹ 4005/-



PR-MATBG-35
Swan Neck
₹ 2635/-



PR-MATBG-34
Sink Cock
₹ 2410/-



Single Lever Divertor Complete
PR-MATBG-56 - 40mm (Normal) ₹ 8020/-
PR-MATBG-59 - 40mm (Hi-Flow) ₹ 8575/-
PR-MATBG-45 - 45mm (Hi-Flow) ₹ 9355/-



PR-MATBG-21P
Bib Cock Project
₹ 1275/-

PR-MATBG-20
Nozzle Bib
₹ 1565/-

PR-MATBG-28
Washing Machine Tap
₹ 1565/-

PR-MATBG-13
Pillar Cock Hi Neck
₹ 3235/-

PR-MATBG-16
Pillar Cock 12"
₹ 4465/-

PR-MATBG-904
Pillar Cock Extra Heavy
₹ 2535/-

PR-MATBG-907
Pillar Cock 9"
₹ 3890/-

PR-MATBG-42
Basin Mixer Q.T.
₹ 5120/-

PR-MATBG-43
Sink Mixer
₹ 5425/-

PR-MATBG-48
S/L/ Basin Mixer 12"
₹ 7865/-

PR-MATBG-61
Plain Spout
₹ 1440/-

PR-MATBG-60
Tipton Spout
₹ 2155/-

PR-MATBG-EXP-01
Divertor Exposed Parts
₹ 4025/-

Single Lever Divertor Body & Fitting
PR-MATBG-DIV-01 - 40mm (Normal) ₹ 3995/-
PR-MATBG-DIV-02 - 40mm (Hi-Flow) ₹ 4550/-
PR-MATBG-DIV-05 - 45mm (Hi-Flow) ₹ 5330/-

PR-MATBG-14
Flush Cock 1" Light
Casted Body ₹ 2255/-

PR-MATBG-23
Flush Cock 1" Medium
Forged Body ₹ 2255/-

PR-MATBG-002
Concealed Flush Valve
₹ 7845/-



PR-RG-47
Single Lever Basin Mixer • ₹ 6180/-



PR-RG-48
Single Lever Basin Mixer 12" Long
₹ 10055/-



PR-RG-16
Pillar Cock 12" Tall
₹ 5530/-



PR-RG-13
Pillar Cock High Neck
₹ 3515/-



PR-RG-11
Pillar Cock
₹ 2665/-



PR-RG-21
Bib Cock
₹ 2265/-



PR-RG-22
Long Body / Long Nose
₹ 2465/-



PR-RG-26
2-in-1 Bib Cock
₹ 3035/-



PR-RG-27
Angle Valve
₹ 1670/-



PR-RG-29
2-in-1 Angle Valve
₹ 3275/-



PR-RG-61
Plain Spout
₹ 2155/-



PR-RG-60
Tipton Spout
₹ 3065/-



PR-RG-64
S/L Wall Mounted Basin Mixer
₹ 10175/-



Single Lever Diverter Complete
PR-RG-56 - 40mm (Normal) ₹ 8020/-
PR-RG-59 - 40mm (Hi-Flow) ₹ 8575/-
PR-RG-45 - 45mm (Hi-Flow) ₹ 9355/-



PR-RG-24
Flush Cock 1" Heavy
₹ 4270/-



PR-RG-34
Sink Cock
₹ 3005/-



PR-RG-35
Swan Neck
₹ 3215/-



PR-RG-40
Wall Mixer with L-Bend
₹ 10940/-



PR-RG-41
3-in-1 Wall Mixer with L-Bend
₹ 12645/-

PR-RG-18
Upper Part of Flush Cock
(Light & Medium) ₹ 1800/-

PR-RG-31
Concerled Stop Cock 15mm
₹ 2220/-

PR-RG-43
Sink Mixer
₹ 6495/-

Single Lever Diverter Body & Fitting
PR-RG-DIV01 - 40mm (Normal) • ₹ 3995/-
PR-RG-DIV02 - 40mm (Hi-Flow) • ₹ 4550/-
PR-RG-DIV05 - 45mm (Hi-Flow) • ₹ 5330/-

PR-RG-EXP01
S/L Diverter Exposed Parts
₹ 4025/-



PR-FG-47
Single Lever Basin Mixer
₹ 6180/-



PR-FG-48
Single Lever Basin Mixer 12" Long
₹ 10055/-



PR-FG-16
Pillar Cock 12" Tall
₹ 5530/-



PR-FG-11
Pillar Cock
₹ 2665/-



PR-FG-21
Bib Cock
₹ 2265/-



PR-FG-22
Long Body / Long Nose
₹ 2465/-



PR-FG-29
2-in-1 Angle Valve
₹ 3275/-



PR-FG-26
2-in-1 Bib Cock
₹ 3035/-



PR-FG-27
Angle Valve
₹ 1670/-



PR-FG-13
Pillar Cock Hi-Neck
₹ 3515/-



PR-FG-60
Tip Ton Spout
₹ 3065/-



PR-FG-61
Plain Spout
₹ 2155/-



PR-FG-35
Swan Neck
₹ 3215/-



PR-FG-64
S/L Wall Mounted Basin Mixer
₹ 10175/-



Single Lever Diverter Complete
PR-FG-56 - 40mm (Normal) ₹ 8020/-
PR-FG-59 - 40mm (Hi-Flow) ₹ 8575/-
PR-FG-45 - 45mm (Hi-Flow) ₹ 9355/-



PR-FG-24
Flush Cock 1" Heavy
₹ 4270/-



PR-FG-34
Sink Cock
₹ 3005/-



PR-FG-43
Sink Mixer
₹ 6495/-



PR-FG-40
Wall Mixer with L-Bend
₹ 10940/-



PR-FG-41
3-in-1 Wall Mixer with L-Bend
₹ 12645/-

PR-FG-18
Upper Part of Flush Cock
(Light & Medium) ₹ 1800/-

PR-FG-31
Concealed Stop Cock 15mm
₹ 2220/-

Single Lever Diverter Body & Fitting
PR-FG-DIV01 - 40mm (Normal) • ₹ 3995/-
PR-FG-DIV02 - 40mm (Hi-Flow) • ₹ 4550/-
PR-FG-DIV05 - 45mm (Hi-Flow) • ₹ 5330/-

PR-FG-EXP01
S/L Diverter Exposed Parts
₹ 4025/-



PR-BL-47
Single Lever Basin Mixer ₹ 6180/-



PR-BL-48
Single Lever Basin Mixer 12" Long ₹ 10055/-



PR-BL-16
Pillar Cock 12" Tall ₹ 5530/-



PR-BL-11
Pillar Cock
₹ 2665/-



PR-BL-21
Bib Cock
₹ 2265/-



PR-BL-22
Long Body / Long Nose
₹ 2465/-



PR-BL-26
2-in-1 Bib Cock
₹ 3035/-



PR-BL-60
Tipton Spout
₹ 3065/-



PR-BL-61
Plain Spout
₹ 2155/-



PR-BL-34
Sink Cock
₹ 3005/-



PR-BL-35
Swan Neck
₹ 3215/-



PR-BL-40
Wall Mixer with L-Bend
₹ 10940/-



PR-BL-41
3-in-1 Wall Mixer with L-Bend
₹ 12645/-

PR-BL-31
Concealed Stop Cock 15mm
₹ 2220/-

PR-BL-43
Sink Mixer
₹ 6495/-

Single Lever Diverter Body & Fitting
PR-BG-DIV01 - 40mm (Normal) • ₹ 3995/-
PR-BG-DIV02 - 40mm (Hi-Flow) • ₹ 4550/-
PR-BG-DIV05 - 45mm (Hi-Flow) • ₹ 5330/-

PR-BG-EXP01
S/L Diverter Exposed Parts
₹ 4025/-



PR-MATB-47
Single Lever Basin Mixer
₹ 5290/-



PR-MATB-40
Wall Mixer with L-Bend
₹ 7505/-



PR-MATB-41
3-in-1 Wall Mixer with Bend
₹ 8835/-



PR-MATB-11
Pillar Cock
₹ 1775/-



PR-MATB-21P
Bib Cock Project
₹ 1205/-



PR-MATB-21
Bib Cock
₹ 1345/-



PR-MATB-22
Long Nose
₹ 1550/-



PR-MATB-26
2-in-1 Bib Cock
₹ 2690/-



PR-MATB-27
Angle Valve
₹ 1345/-



PR-MATB-60
Tipton Spout
₹ 2050/-



PR-MATB-61
Plain Spout
₹ 1440/-



Single Lever Divertor Complete
PR-MATB-56 - 40mm (Normal) ₹ 7000/-
PR-MATB-59 - 40mm (Hi-Flow) ₹ 7555/-
PR-MATB-45 - 45mm (Hi-Flow) ₹ 8335/-



Concealed Stop Cock (Fitting 15mm)
PR-MATB-31 - 15mm • ₹ 1945/-
PR-MATB-32 - 20mm • ₹ 1995/-



PR-MATB-35
Swan Neck (J Spout)
₹ 2560/-



PR-MATB-34
Sink Cock
₹ 2335/-



PR-MATB-002
Concealed Flush Valve
₹ 6945/-

PR-MATB-20
Nozzel Bib Cock
₹ 1490/-

PR-MATB-28
Washing Machine Tap
₹ 1490/-

PR-MATB-13
Pillar Cock Hi-Neck
₹ 3160/-

PR-MATB-16
Pillar Cock 12" Tall
₹ 4390/-

PR-MATB-14
Flush Cock 1" Light
Casted Body ₹ 2180/-

PR-MATB-29
2 in 1 Angle Valve
₹ 2690/-

PR-MATB-904
Pillar Cock Extra Heavy
₹ 2460/-

PR-MATB-23 - Flush Cock 1"
Medium Forged Body ₹ 2180/-

PR-MATB-24
Flush Cock 1" Heavy ₹ 3935/-

PR-MATB-42
Basin Mixer Quarter Turn ₹ 5120/-

PR-MATB-48
S/L Basin Mixer 12" Long ₹ 7865/-



PR-MB-47
Single Lever Basin Mixer
₹ 4600/-



PR-MB-42
Basin Mixer Quarter Turn
₹ 4450/-

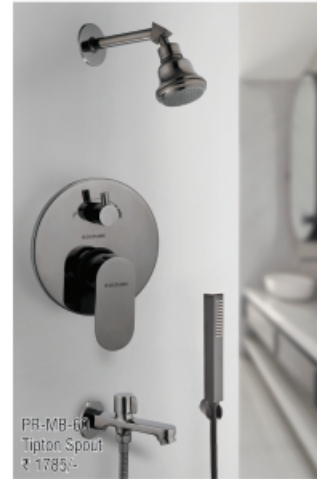

PR-MB-60
Tipton Spout
₹ 1785/-

Single Lever Diverter Complete
PR-MB-56 - 40mm (Normal) ₹ 6610/-
PR-MB-59 - 40mm (Hi-Flow) ₹ 7165/-
PR-MB-45 - 45mm (Hi-Flow) ₹ 7945/-



PR-MB-13
Pillar Cock High Neck
₹ 2745/-



PR-MB-11
Pillar Cock
₹ 1540/-



PR-MB-904
Pillar Cock Extra Heavy
₹ 2135/-



PR-MB-21
Bib Cock
₹ 1175/-



PR-MB-22P
Bib Cock Project
₹ 1055/-



PR-MB-22
Long Nose (Extra Long)
₹ 1340/-



PR-MB-27
Angle Valve
₹ 1175/-



PR-MB-29
2-in-1 Angle Valve
₹ 2335/-



PR-MB-14
Flush Cock 1" Light
₹ 1890/-



PR-MB-930
Concealed Wall Mixer Complete
₹ 8465/-



PR-MB-61
Plain Spout
₹ 1250/-



PR-MB-35
Swan Neck
₹ 2225/-



PR-MB-16
Pillar Cock 12" Tall
₹ 3815/-



PR-MB-34
Sink Cock
₹ 2030/-



PR-MB-43
Sink Mixer
₹ 4715/-



PR-MB-903
Sink Cock Extended Spout
₹ 2295/-



PR-MB-40
Wall Mixer with L-Bend
₹ 6525/-

PR-MB-20
Nozzel Bib Cock
₹ 1295/-

PR-MB-48
S/L Basin Mixer 12"
Long ₹ 7990/-

PR-MB-24
Flush Cock 1" Heavy
₹ 3420/-

PR-MB-26 - 2 in 1 Bib Cock ₹ 2335/-

PR-MB-907 - Pillar Cock 9" ₹ 3320/-

PR-MB-28 - Washing Machine Tap ₹ 1295/-

PR-MB-EXP01

S/L Diverter Exposed Parts ₹ 2615/-

PR-MB-23 -
Flush Cock 1" Medium
Forged Body ₹ 1890/-

PR-MB-58
S/L Sink Mixer T.M.
₹ 7630/-

PR-MB-64
S/L Wall Mounted Basin
Mixer ₹ 8555/-

Single Lever Diverter Body & Fitting
PR-MB-DIV01 - 40mm (Normal) • ₹ 3995/-
PR-MB-DIV02 - 40mm (Hi-Flow) • ₹ 4550/-
PR-MB-DIV05 - 45mm (Hi-Flow) • ₹ 5330/-
Concealed Stop Cock (Fitting 15mm)
PR-MB-31 - 15mm ₹ 1690/-
PR-MB-32 - 20mm ₹ 1730/-



PR-CG-47
Single Lever Basin Mixer
₹ 4355/-



PR-CG-48
Single Lever Basin Mixer 12" Long
₹ 6915/-



PR-CG-11
Pillar Cock
₹ 1590/-



PR-CG-21
Bib Cock
₹ 1310/-



PR-CG-22
Long Body / Long Nose
₹ 1435/-



PR-CG-27
Angle Valve
₹ 1310/-



PR-CG-26
2-in-1 Bib Cock
₹ 2190/-



PR-CG-35
Swan Neck
₹ 2115/-



PR-CG-34
Sink Cock
₹ 1970/-



PR-CG-16
Pillar Cock 12" Tall
₹ 3515/-



PR-CG-40
Wall Mixer with L-Bend
₹ 6835/-

PR-CG-13
Pillar Cock Hi-Neck ₹ 2355/-

PR-CG-43
S/L Sink Mixer ₹ 4915/-

PR-CG-29
2-in-1 Angle Valve ₹ 2440/-

PR-CG-61
Plain Spout ₹ 1305/-

PR-CG-60
Tipton Spout ₹ 1760/-

PR-CG-EXP-01
Divertor Exposed Part ₹ 4025/-

PR-CG-31 - Concealed
Stop Cock 15mm ₹ 1760/-

PR-CG-41
3 in 1 Wall Mixer with Bend
₹ 8075/-

Single Lever Diverter Complete
PR-CG-56 - 40mm (Normal) • ₹ 8020/-
PR-CG-59 - 40mm (Hi-Flow) • ₹ 8575/-
PR-CG-45 - 45mm (Hi-Flow) • ₹ 9355/-

Single Lever Diverter Body & Fitting
PR-CG-DIV01 - 40mm (Normal) • ₹ 3995/-
PR-CG-DIV02 - 40mm (Hi-Flow) • ₹ 4550/-
PR-CG-DIV05 - 45mm (Hi-Flow) • ₹ 5330/-



PR-47
Single Lever Basin Mixer
₹ 3775/-



PR-48
Single Lever Basin Mixer 12" Long
₹ 5650/-



PR-42
Basin Mixer Quarter Turn
₹ 3650/-



PR-64
S/L Wall Mounted Basin Mixer
₹ 6405/-



PR-11
Pillar Cock
₹ 1255/-



PR-904
Pillar Cock Extra Heavy
₹ 1750/-



PR-13
Pillar Cock High Neck
₹ 2250/-



PR-907
Pillar Cock 9"
₹ 2610/-



PR-21P
Bib Cock (Project)
₹ 850/-



PR-21
Bib Cock / Long Nose Project
₹ 960/-



PR-22
Long Nose (Extra Long)
₹ 1095/-



PR-26
2-in-1 Bib Cock
₹ 1915/-



PR-20
Nozzle Bib Cock
₹ 960/-



PR-28
Washing Machine Tap
₹ 960/-



PR-29
2-in-1 Angle Valve
₹ 1915/-



PR-27
Angle Valve
₹ 965/-



PR-27P
Angle Valve (Project)
₹ 860/-



PR-61
Plain Spout
₹ 1030/-



PR-60
Tip on Spout
₹ 1470/-



Concealed Stop Cock
(Fitting 15mm)
PR-31 - 15mm • ₹ 1440/-
PR-32 - 20mm • ₹ 1475/-



Concealed Stop Cock
(Fitting 20mm)
PR-12 - 15mm • ₹ 1695/-
PR-12A - 20mm • ₹ 1725/-



PR-14
Flush Cock 1" Light Casted Body
₹ 1620/-



PR-23
Flush Cock 1" Medium Forged Body
₹ 1620/-



PR-68
Wall Mounted Basin Tap Complete
₹ 4030/-

PR-15
Flush Cock (Light) Body & Fitting
₹ 850/-

PR-17
Flush Cock (Medium) Body & Fitting
₹ 850/-

PR-18
Upper Part of Flush Cock (Light & Medium)
₹ 770/-

PR-19
Flush Cock (Heavy) Body & Fitting
₹ 1800/-

PR-25
Upper Part of Flush Cock (Heavy)
₹ 1000/-

PR-24
Flush Cock 1" Heavy
₹ 2800/-



Single Lever Diverter Complete
PR-56 - 40mm (Normal) ₹ 5880/-
PR-59 - 40mm (Hi-Flow) ₹ 6435/-
PR-45 - 45mm (Hi-Flow) ₹ 7215/-
PR-70 - 46mm (3-in-let) ₹ 8105/-



PR-EXP 01
Single Lever Diverter Exposed
Parts Handle & Plate (Suitable
for DIV-01 & DIV-02) ₹ 1885/-



PR-50
Single Lever Wall Mixer
₹ 5515/-



PR-45
Single Lever Shower Mixer
₹ 5000/-



PRCWM-930
Concealed Body
Wall Mixer Complete
₹ 7000/-



PR-16
Pillar Cock 12" Tall
₹ 2905/-



PR-71
Side Knob Long Height
Pillar Cock
₹ 3720/-



PR-35
Swan Neck (J Spout)
₹ 1825/-



PR-67
Swan Neck Coloured Spout
₹ 2045/-



PR-901
Swan Neck Extra Big
Round Spout
₹ 2420/-



PR-34
Sink Cock (J Spout)
₹ 1665/-



PR-903
Sink Cock Extended Spout
₹ 1930/-



PR-66
Sink Cock Coloured Spout
₹ 1910/-



PR-902
Sink Cock Extra Big Round Spot
₹ 2305/-



PR-43
Sink Mixer
₹ 3870/-



PR-49
Single Lever Sink Mixer
(Wall Mounted) ₹ 5380/-



PR-906
Sink Mixer with Flexible C Pipe
₹ 4450/-



Note :
MOQ - 80 Pcs
PRPJ-916P
Wall Mixer with Bend (Project)
₹ 4860/-



PR-41
3-in-1 Wall Mixer with L-Bend
₹ 6300/-



Note :
30mm Cartridge
for smooth flow
PR-40
Wall Mixer with L-Bend
₹ 5450/-

PR-44
Non telephonic
₹ 4085/-

PR-58
S/L Sink Mixer T.M.
₹ 5200/-

Single Lever Diverter Body & Fitting
PR-DIV01 - 40mm (Normal) • ₹ 3995/-
PR-DIV02 - 40mm (Hi-Flow) • ₹ 4550/-
PR-DIV05 - 45mm (Hi-Flow) • ₹ 5330/-

Concealed Body Wall Mixer
Body & Fitting ₹ 3500/-

Concealed Body Wall Mixer
Exposed Parts ₹ 3500/-

RANGE
NO. 8H

Prime

CHROME PLATED

GOLDLINE

The New Age Bath Fittings



PR-EXP 01
Single Lever Diverter Exposed
Parts Handle & Plate (Suitable
for DIV-01 & DIV-02)
₹ 1885/-

PR-60
Tip Ton Spout
₹ 1470/-

NEW

(Bigger Premix)

RANGE
NO. 8H

Prime

CHROME PLATED

GOLDLINE

The New Age Bath Fittings



PR-40
Wall Mixer with L-Bend
₹ 5450/-



TR-42
Basin Mixer Quarter Turn
₹ 3650/-



TR-13
Pillar Cock High Neck
₹ 2250/-



TR-904
Pillar Cock Extra Heavy
₹ 1750/-



TR-11
Pillar Cock
₹ 1255/-



TR-21P
Bib Cock (Project)
₹ 850/-



TR-21
Bib Cock / Long Nose
Project
₹ 960/-



TR-22E
(New Extra) Long Nose
₹ 1095/-



TR-26
2-in-1 Bib Cock
₹ 1915/-



TR-28
Washing Machine Tap
₹ 960/-



TR-20
Nozzle Bib Cock
₹ 960/-



TR-27
Angle Valve
₹ 965/-



TR-29
2-in-1 Angle Valve
₹ 1915/-



TR-27P
Angle Valve (Project)
₹ 860/-



Concealed Stop Cock
(Fitting 15mm)
TR-31 - 15mm • ₹ 1440/-
TR-32 - 20mm • ₹ 1475/-



Concealed Stop Cock
(Fitting 20mm)
TR-12 - 15mm • ₹ 1695/-
TR-12A - 20mm • ₹ 1725/-



TR-23
Flush Cock 1" Medium
Forged Body SS-304
₹ 1620/-



TR-14
Flush Cock 1" Light
Casted Body
₹ 1620/-



TR-901
Swan Neck Extra Big
Round Spout
₹ 2420/-



TR-35
Swan Neck (J Spout)
₹ 1825/-



TR-903
Sink Cock Extended Spout
₹ 1930/-



TR-905
Center Hole with Flexible C Pipe
₹ 4010/-



TR-16
Pillar Cock 12" Tall
₹ 2905/-



TR-34
Sink Cock (J Spout)
₹ 1665/-



TR-902
Sink Cock Extra Big Round Spout
₹ 2305/-



TR-43
Sink Mixer
₹ 3870/-



TR-906
Sink Mixer with Flexible C Pipe
₹ 4450/-



TR-40
Wall Mixer with L-Bend / Crutch
₹ 5450/-



TR-41
3-in-1 Wall Mixer with L-Bend
₹ 6300/-

TR-15
Flush Cock (Light)
Body & Fitting ₹ 850/-

TR-66
Sink Cock Coloured
Spout ₹ 1910/-

TR-67
Swan Neck Coloured
Spout ₹ 2045/-

TR-18
Upper Part of Flush Cock
(Light & Medium) ₹ 770/-

TR-19
Flush Cock (Heavy)
Body & Fitting ₹ 1800/-

TR-44
Non Telephonic
₹ 3870/-

TR-17
Flush Cock (Medium)
Body & Fitting ₹ 850/-

TR-48 Single Lever Basin Mixer 12" Long ₹ 5650/-

TR-907 Pillar Cock 9" ₹ 2610/-



NO-42
Basin Mixer Quarter Turn
₹ 3405/-



NO-40
Wall Mixer with L-Bend
₹ 4695/-



NO-41
3-in-1 Wall Mixer with L-Bend
₹ 5685/-



NO-11
Pillar Cock
₹ 1055/-



NO-21
Bib Cock
₹ 825/-



NO-22
Long Body
₹ 870/-



NO-27
Angle Valve
₹ 510/-



NO-26
2-in-1 Bib Cock
₹ 1590/-



NO-14
Flush Cock (Light)
Casted Body
₹ 1600/-



NO-23
Flush Cock 1" Medium
Forged Body SS-304
₹ 1600/-



Concealed Stop Cock
(Fitting 15mm)
NO-31 - 15mm • ₹ 1350/-
NO-32 - 20mm • ₹ 1350/-



NO-24
Flush Cock 1" Heavy
₹ 2800/-



NO-34
Sink Cock (J Spout)
₹ 1495/-



NO-35
Swan Neck (J Spout)
₹ 1635/-



NO-43
Sink Mixer
₹ 3625/-

NO-29
2 in 1 Angle Valve
₹ 1705/-

NO-16
Pillar Cock 12"
₹ 2905/-



CF-42
Basin Mixer Quarter Turn
₹ 3405/-



CF-40
Wall Mixer with L-Bend / Crutch
₹ 4695/-



CF-21
Bib Cock
₹ 825/-



CF-22
Long Nose
₹ 885/-



CF-11
Pillar Cock
₹ 1060/-



CF-27
Angle Valve
₹ 510/-



CF-26
2-in-1 Bib Cock
₹ 1470/-



CF-61
Plain Spout
₹ 1030/-



Concealed Stop Cock
(Fitting 15mm)
CF-31 - 15mm • ₹ 1330/-
CF-32 - 20mm • ₹ 1330/-



CF-23
Flush Cock 1" Medium
Forged Body SS-304
₹ 1600/-



CF-14
Flush Cock 1" Light
Casted Body
₹ 1600/-



CF-34
Sink Cock (J Spout)
₹ 1495/-



CF-35
Swan Neck (J Spout)
₹ 1635/-



CF-43
Sink Mixer
₹ 3625/-

CF-29
2 in 1 Angle Valve
₹ 1705/-

CF-41
3 in 1 Wall Mixer with Basin
₹ 5685/-

CF-16
Pillar Cock 12"
₹ 2905/-



ES-42
Basin Mixer Quarter Turn
₹ 3405/-



ES-40
Wall Mixer with L-Bend
₹ 4795/-



ES-41
3-in-1 Wall Mixer with L-Bend
₹ 5650/-



ES-11
Pillar Cock
₹ 1010/-



ES-21
Bib Cock
₹ 865/-



ES-22
Long Body
₹ 990/-



ES-27
Angle Valve
₹ 865/-



ES-26
2-in-1 Bib Cock
₹ 1960/-



ES-14
Flush Cock (Light)
Casted Body
₹ 1600/-



ES-23
Flush Cock 1" Medium
Forged Body SS-304
₹ 1680/-



Concealed Stop Cock
(Fitting 15mm)
ES-31 - 15mm • ₹ 1410/-
ES-32 - 20mm • ₹ 1410/-



ES-24
Flush Cock 1" Heavy
₹ 2800/-



ES-34
Sink Cock (J Spout)
₹ 1750/-



ES-35
Swan Neck (J Spout)
₹ 1900/-



ES-43
Sink Mixer
₹ 3675/-

ES-29
2 in 1 Angle Valve
₹ 1960/-

ES-30
Sink Cock (Casted Spout)
₹ 1900/-



ZS-42
Basin Mixer Quarter Turn
₹ 3445/-



ZS-40
Wall Mixer with L-Bend
₹ 4795/-



ZS-41
3-in-1 Wall Mixer with L-Bend
₹ 5650/-



ZS-11
Pillar Cock
₹ 1010/-



ZS-21
Bib Cock
₹ 865/-



ZS-22A
Long Body
₹ 990/-



ZS-27
Angle Valve
₹ 865/-



ZS-26
2-in-1 Bib Cock
₹ 1960/-



ZS-23
Flush Cock 1" Medium Forged Body
SS-304 ₹ 1680/-



Concealed Stop Cock (Fitting 15mm)
ZS-31 - 15mm | ₹ 1410/-
ZS-32 - 20mm | ₹ 1410/-



ZS-35
Swan Neck (J Spout)
₹ 1900/-



ZS-30
Sink Cock (Casted Spout)
₹ 1900/-



ZS-34
Sink Cock (J Spout)
₹ 1750/-



ZS-43
Sink Mixer
₹ 3675/-

ZS-29
2-in-1 Angle Valve
₹ 1960/-

ZS-44
Non Telephonic
₹ 3675/-



LX-42
Center Hole Quarter Turn
₹ 3580/-



LX-40
Wall Mixer with L-Bend
₹ 4970/-



LX-41
3-in-1 Wall Mixer with L-Bend
₹ 6000/-



LX-11
Pillar Cock
₹ 1155/-



LX-21
Bib Cock
₹ 1060/-



LX-22
Long Nose
₹ 1155/-



LX-27
Angle Valve
₹ 955/-



LX-27P
Project Angle Valve
₹ 685/-



LX-26
2-in-1 Bib Cock
₹ 1865/-



LX-29
2-in-1 Angle Valve
₹ 1945/-



Concealed Stop Cock
(Fitting 15mm)
LX-31 - 15mm • ₹ 1550/-
LX-32 - 20mm • ₹ 1590/-



LX-16
Pillar Cock 12" Tall
₹ 2870/-



LX-34
Sink Cock (J Spout)
₹ 1610/-



LX-35
Swan Neck (J. Spout)
₹ 1725/-

LX-23
Flush Cock 1" Medium
Forged Body SS-304 ₹ 1750/-

LX-24
Flush Cock 1" Heavy
₹ 2800/-

LX-43 Sink Mixer
₹ 3810/-

LX-20
Nozzle Bib Cock
₹ 960/-

LX-28
Washine Machine
₹ 960/-

Note : In this range with flange.



CN-42
Basin Mixer Quarter Turn
₹ 4170/-



CN-13
Pillar Cock Hi-Neck
₹ 2210/-



CN-11
Pillar Cock
₹ 1330/-



CN-913
Pillar Cock Long Nose
₹ 2035/-



CN-33
Swan Neck (Casted Spout)
₹ 2680/-



CN-21
Bib Cock
₹ 1155/-



CN-22
Long Body
₹ 1360/-



CN-22A
Long Nose
₹ 1395/-



CN-26
2-in-1 Bib Cock
₹ 2070/-



CN-27
Angle Valve
₹ 1115/-



CN-29
2-in-1 Angle Valve
₹ 2305/-



CN-20
Nozzle Bib Cock
₹ 1400/-



CN-23
Flush Cock 1" Medium
Forged Body
₹ 1620/-



CN-24
Flush Cock 1" Heavy
₹ 2800/-



Concealed Stop Cock
(Fitting 15mm)
CN-31 - 15mm • ₹ 1610/-
CN-32 - 20mm • ₹ 1645/-



CN-91
Long Body Extra Heavy
Extra Long ₹ 2145/-



Concealed Stop Cock
(Fitting 20mm)
CN-12 - 15mm • ₹ 1695/-
CN-12A - 20mm • ₹ 1725/-



CN-60
Tip Ton Spout
₹ 2800/-



CN-61
Plain Spout
₹ 1365/-



CN-25
Sink Cock Side Handle
₹ 2520/-



CN-63
2-in-1 Sink Cock
₹ 3035/-



CN-35
Swan Neck (J Spout)
₹ 2375/-



CN-34
Sink Cock (J Spout)
₹ 2180/-



CN-30
Sink Cock (Casted Spout)
₹ 2500/-



CN-43
Sink Mixer
₹ 4740/-



CN-44
Wall Mixer Non-Telephonic
₹ 4740/-



CN-901
Swan Neck Extra Big
Round Spout
₹ 2905/-



CN-902
Sink Cock Extra Big
Round Spout
₹ 2705/-



CN-903
Sink Cock Extended Spout
₹ 2470/-



CN-40
Wall Mixer with L-Bend / Crutch
₹ 6200/-
CN-38 Wall Mixer w/o bend
₹ 5625/-



CN-41
3-in-1 Wall Mixer with L-Bend
₹ 7190/-

CN-43 EX
Sink Mixer Casted Spout
₹ 4655/-

CN-14
Flush Cock 1" Light Casted Body
₹ 1620/-

CN-67
Swan Neck Coloured Spout
₹ 2520/-

CN-66
Sink Cock Coloured Spout
₹ 2340/-



AX-42
Basin Mixer Quarter Turn
₹ 3605/-



AX-21
Bib Cock
₹ 955/-



AX-22
Long Nose
₹ 1130/-



AX-26
2-in-1 Bib Cock
₹ 2035/-



AX-27
Angle Valve
₹ 925/-



AX-29
2-in-1 Angle Valve
₹ 2035/-



AX-23
Flush Cock Medium 1"
Forged Body SS-304
₹ 1620/-



AX-24
Flush Cock 1" Heavy
₹ 2800/-



Concealed Stop Cock
(Fitting 15mm)
AX-31 - 15mm • ₹ 1440/-
AX-32 - 20mm • ₹ 1475/-



AX-20
Nozzle Bib Cock
₹ 960/-



AX-11
Pillar Cock
₹ 1155/-



AX-35
Swan Neck (J Spout)
₹ 1970/-



AX-28
Washing Machine Tap
₹ 960/-



AX-44
Wall Mixer Non-Telephonic
₹ 3970/-



AX-34
Sink Cock (J Spout)
₹ 1860/-



AX-902
Sink Cock Extra Big Round Spout
₹ 2380/-



AX-903
Sink Cock Extended Spout
₹ 2135/-



AX-43
Sink Mixer
₹ 3970/-



AX-901
Swan Neck Extra Big Round Spout
₹ 2490/-



AX-16
Pillar Cock 12" Tall
₹ 2905/-



AX-40
Wall Mixer with L-Bend / Crutch
₹ 5380/-



AX-41
3-in-1 Wall Mixer with L-Bend
₹ 6465/-

AX-13
Pillar Cock Hi-Neck
₹ 2250/-

AX-14
Flush Cock 1" Light Casted Body
₹ 1620/-

AX-44
Non Telephonic
₹ 3970/-



CB-42
Basin Mixer Quarter Turn ₹ 4405/-



CB-61
Plain Spout
₹ 1115/-

Single Lever Diverter Complete
CB-56 - 40mm (Normal) ₹ 5880/-
CB-59 - 40mm (Hi-Flow) ₹ 6435/-
CB-45 - 45mm (Hi-Flow) ₹ 7215/-



CB-40
Wall Mixer with L-Bend
₹ 6075/-

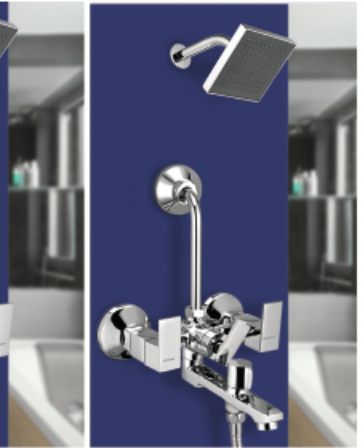

CB-41
3-in-1 Wall Mixer with Bend
₹ 6755/-



CB-47
Single Lever Basin Mixer
₹ 5990/-



CB-11
Pillar Cock Foam Flow
₹ 1680/-



CB-21
Bib Cock
₹ 1350/-



CB-22
Long Body /Long Nose
₹ 1515/-



CB-26
2-in-1 Bib Cock
₹ 2380/-



Concealed Stop Cock (Fitting 15mm)
CB-31 - 15mm • ₹ 1635/-
CB-32 - 20mm • ₹ 1665/-



CB-24
Flush Cock 1" Heavy
₹ 2800/-



CB-27
Angle Valve
₹ 1180/-



CB-29
2-in-1 Angle Valve
₹ 2700/-



CBCWM-930
Concealed Wall Mixer Complete
₹ 7255/-



CB-60
Tip Ton Spout
₹ 1635/-



CB-35
Swan Neck (J. Spout)
₹ 2240/-



CB-34
Sink Cock (J. Spout)
₹ 2090/-



CB-901
Swan Neck Extra Big Round Spout
₹ 2780/-



CB-902
Sink Cock Extra Big Round Spout
₹ 2660/-



CB-903
Sink Cock Extended Spout
₹ 2300/-



CB-16
Pillar Cock 12" Tall
₹ 4675/-

CB-42
Basin Mixer Quarter Turn ₹ 4405/-

CB-66
Sink Cock Coloured Spout ₹ 2460/-

CB-44
Non Telephonic ₹ 1665/-

CB-14
Flush Cock Light Casted Body ₹ 1665/-

CB-EXP01
S/L Diverter Exposed Parts ₹ 1885/-

Single Lever Diverter Body & Fitting
CB-DIV01 - 40mm (Normal) ₹ 3995/-
CB-DIV02 - 40mm (Hi-Flow) ₹ 4550/-
CB-DIV05 - 40mm (Hi-Flow) ₹ 5330/-

Concealed Stop Cock (Fitting 15mm)
CB-12 - 15mm ₹ 1720/-
CB-12A - 20mm ₹ 1750/-

CB-907 Pillar Cock 9" ₹ 4445/-
CB-43 - Sink Mixer ₹ 4675/-
CB-20 - Nozzle Bib Cock ₹ 1075/-

CB-67 Swan Neck Coloured Spout ₹ 2640/-

CB-48 S/L Basin Mixer 12" ₹ 7375/-

CB-23 - Flush Cock 1" Medium Forged Body SS-304 ₹ 1665/-



AA-47
Single Lever Basin Mixer
₹ 5085/-



AA-13
Pillar Cock High Neck
₹ 2415/-



AA-11
Pillar Cock
₹ 1520/-



AA-904
Pillar Cock Extra Heavy
Long Height & Long Nose
₹ 1995/-



AACWM-930
Concealed Wall Mixer Complete
₹ 7255/-



AA-21
Bib Cock
₹ 1165/-



AA-22
Long Nose
₹ 1360/-



AA-921 Long Nose
(Extra Long Nose)
₹ 1515/-



AA-26
2-in-1 Bib Cock
₹ 2380/-



AA-23
Flush Cock 1" Medium
Forged Body SS-304
₹ 1620/-



AA-14
Flush Cock (Light)
Casted Body
₹ 1620/-



Concealed Stop Cock
(Fitting 15mm)
AA-31 - 15mm ₹ 1635/-
AA-32 - 20mm ₹ 1665/-



Concealed Stop Cock
(Fitting 20mm)
AA-12 - 15mm ₹ 1720/-
AA-12A - 20mm ₹ 1750/-



AA-24
Flush Cock 1" Heavy
₹ 2800/-



AA-35
Swan Neck (J. Spout)
₹ 2140/-



AA-67
Swan Neck Coloured Spout
₹ 2515/-



Single Lever Diverter Complete
AA-56 - 40mm (Normal) ₹ 5880/-
AA-59 - 40mm (Hi-Flow) ₹ 6435/-
AA-45 - 45mm (Hi-Flow) ₹ 7215/-



AA-60
Tip Ton Spout
₹ 1995/-



AA-61
Plain Spout
₹ 1390/-



AA-34
Sink Cock (J. Spout)
₹ 2015/-



AA-66
Sink Cock Coloured Spout
₹ 2340/-



AA-903
Sink Cock Extended Spout
₹ 2300/-



AA-907
Pillar Cock 9"
₹ 2790/-



AA-902
Sink with Big Round Spout
₹ 2660/-



AA-901
Swan Neck Big
Round Spout ₹ 2780/-



AA-42
Basin Mixer Quarter Turn
₹ 4400/-



AA-16
Pillar Cock 12" Tall
₹ 3040/-



AA-40
Wall Mixer with L-Bend
₹ 6075/-

AA-27
Angle Valve
₹ 1165/-

AA-29
2 in 1 Angle Valve
₹ 2700/-

AA-44
Non Telephonic
₹ 4675/-

AA-41
3 in 1 Wall Mixer
with Bend
₹ 6755/-

AA-43
Sink Mixer
₹ 4675/-

AA-27P
Angle Valve Project
₹ 930/-

Single Lever Diverter Body & Fitting
AA-DIV01 - 40mm (Normal) • ₹ 3995/-
AA-DIV02 - 40mm (Hi-Flow) • ₹ 4550/-
AA-DIV03 - 45mm (Hi-Flow) • ₹ 5330/-

AA-Exp-01
Diverter Exposed
Parts ₹ 1885/-

AA-48
Single Lever Basin Mixer 12" ₹ 5990/-



AA-MB-47
Single Lever Basin Mixer
₹ 6200/-

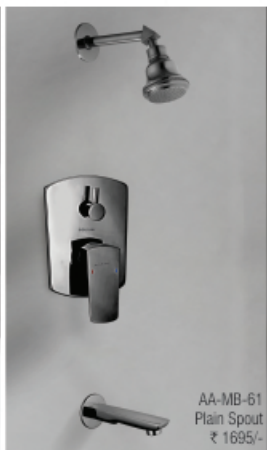

AA-MB-61
Plain Spout
₹ 1695/-
Single Lever Diverter Complete
AA-MB-56 - 40mm (Normal) ₹ 6965/-
AA-MB-59 - 40mm (Hi-Flow) ₹ 7520/-
AA-MB-45 - 45mm (Hi-Flow) ₹ 8300/-



AA-MB-40
Wall Mixer with L-Bend
₹ 7410/-



AA-MB-41
3-in-1 Wall Mixer with Bend
₹ 8240/-



AA-MB-11
Pillar Cock
₹ 1850/-



AA-MB-13
Pillar Cock High Neck
₹ 2940/-



AA-MB-904
Pillar Cock Heavy
₹ 2435/-



AA-MB-16
Pillar Cock 12" Tall
₹ 3980/-



AA-MB-35
Swan Neck (J. Spout)
₹ 2610/-



AA-MB-21
Bib Cock
₹ 1415/-



AA-MB-22
Long Nose
₹ 1660/-



AA-MB-27
Angle Valve
₹ 1415/-



AA-MB-26
2-in-1 Bib Cock
₹ 2905/-



AA-MB-921
Long Nose Extra Long
₹ 1845/-



AA-MB-930
Concealed Wall Mixer Complete
₹ 8165/-



AA-MB-60
Tip Ton Spout
₹ 2435/-



AA-MB-14
Flush Cock (Light) Casted Body
₹ 1960/-



Con. Stop Cock (Fitting 20mm)
AA-MB-12 - 15mm ₹ 2090/-
AA-MB-12A - 20mm ₹ 2120/-



Con. Stop Cock (Fitting 15mm)
AA-MB-31 - 15mm ₹ 1995/-
AA-MB-32 - 20mm ₹ 2035/-



AA-MB-34
Sink Cock (J. Spout)
₹ 2460/-



AA-MB-901
Swan Neck Big Round Spout
₹ 3390/-



AA-MB-902
Sink Cock Big Round Spout
₹ 3275/-



AA-MB-903
Sink Cock Extended Spout
₹ 2805/-

AA-MB-907 - Pillar Cock 9" ₹ 3435/-
AA-MB-29 - 2 in 1 Angle Valve ₹ 3295/-
AA-MB-23 - Flush Code 1" Medium Forged Body ₹ 2405/-

AA-MB-24 - Flush Cock 1" Heavy ₹ 3420/-
AA-MB-43 - Sink Mixer ₹ 5700/-
AA-MB-44 - Non Telephonic ₹ 5700/-
AA-MB-48 Single Lever Basin Mixer 12" ₹ 7305/-

Single Lever Diverter Body & Fitting
AA-MB-DIV01 - 40mm (Normal) • ₹ 3995/-
AA-MB-DIV02 - 40mm (Hi-Flow) • ₹ 4550/-
AA-MB-DIV05 - 45mm (Hi-Flow) • ₹ 5330/-

AA-Exp01
Diverter Exposed Parts
₹ 2970/-



CAR-16
Pillar Cock 12" Tall
₹ 2905/-



CAR-40
Wall Mixer with L-Bend
₹ 5510/-



CAR-41
3-in-1 Wall Mixer with L-Bend
₹ 6300/-



CAR-11
Pillar Cock
₹ 1370/-



CAR-21
Bib Cock
₹ 1015/-



CAR-22
Long Nose
₹ 1195/-



CAR-27P
Angle Valve (Project)
₹ 885/-



CAR-27
Angle Valve
₹ 985/-



CAR-26
2-in-1 Bib Cock
₹ 1990/-



CAR-29
2-in-1 Angle Valve
₹ 1915/-



CAR-14
Flush Cock 1" Light Casted Body
₹ 1620/-



Concealed Stop Cock (Fitting 15mm)
CAR-31 - 15mm | ₹ 1440/-
CAR-32 - 20mm | ₹ 1470/-



CAR-23
Flush Cock 1" Medium Forged
Body ₹ 1620/-



CAR-24
Flush Cock 1" Heavy
₹ 2800/-



CAR-34
Sink Cock (J Spout)
₹ 1730/-



CAR-35
Swan Neck (J Spout)
₹ 1855/-

Single Lever Diverter Complete
CAR-56 - 40mm (Normal) ₹ 5880/-
CAR-59 - 40mm (Hi-Flow) ₹ 6435/-
CAR-45 - 45mm (Hi-Flow) ₹ 7215/-
CAR-21P Bib Cock Project ₹ 1070/-
CAR-916P
Wall Mixer with Bend Project
₹ 5135/-

CAR-42 Basin Mixer
Quarter Turn ₹ 3990/-
CAR-13 Pillar Cock
Hi-Neck ₹ 2340/-
Concealed Stop Cock
(Fitting 20mm)
CAR-12 - 15mm | ₹ 1695/-
CAR-12A - 20mm | ₹ 1730/-

CAR-930 Concealed Body
Wall Mixer Complete ₹ 7255/-
CAR-44 Non Telephonic ₹ 4425/-
CAR-61 Plain Spout ₹ 1145/-
CAR-43 Sink Mixer ₹ 4425/-
CAR-60 Tip Ton Spout ₹ 1590/-
CAR-48 S/L Basin Mixer 12" Long ₹ 5875/-

CAR-66 Sink Cock Coloured Spout ₹ 2255/-
CAR-67 Swan Neck Cock Coloured Spout ₹ 2520/-
CAR-47 Single Lever Basin Mixer ₹ 4590/-
CAR-901 Swan Neck Extra Big Round Spout ₹ 2660/-
CAR-902 Sink Cock Extra Big Round Spout ₹ 2600/-
CAR-903 Sink Cock Extended Spout ₹ 2250/-
CAR-EXP-01 Single Lever Diverter Exposed Parts ₹ 1885/-

Note : The above range comes without wall flange.



CAM-16
Pillar Cock 12" Tall
₹ 2905/-



CAM-40
Wall Mixer with L-Bend / Crutch
₹ 5510/-



CAM-41
3-in-1 Wall Mixer with L-Bend
₹ 6330/-



CAM-11
Pillar Cock
₹ 1415/-



CAM-21
Bib Cock
₹ 1030/-



CAM-22
Long Nose
₹ 1225/-



CAM-27
Angle Valve
₹ 1005/-



CAM-26
2-in-1 Bib Cock
₹ 1990/-



CAM-29
2-in-1 Angle Valve
₹ 1915/-



Concealed Stop Cock (Fitting 15mm)
CAM-31 - 15mm | ₹ 1460/-
CAM-32 - 20mm | ₹ 1490/-



CAM-23
Flush Cock 1" Medium
Forged Body
₹ 1650/-



CAM-24
Flush Cock 1" Heavy
₹ 2680/-



CAM-34
Sink Cock (J Spout)
₹ 1750/-



CAM-35
Swan Neck (J Spout)
₹ 1865/-

Single Lever Diverter Complete
CAM-56 - 40mm (Normal) ₹ 5880/-
CAM-59 - 40mm (Hi-Flow) ₹ 6435/-
CAM-45 - 45mm (Hi-Flow) ₹ 7215/-
Concealed Stop Cock (Fitting 20mm)
CAM-12 - 15mm ₹ 1730/-
CAM-12A - 20mm ₹ 1765/-
CAM-13 Pillar Cock Hi-Neck ₹ 2385/-
CAM-21P Bib Cock Project ₹ 1130/-
CAM-27P Angle Valve (Project) ₹ 905/-

Single Lever Diverter Body & Fitting
CAM-DIV01 - 40mm (Normal) ₹ 3995/-
CAM-DIV02 - 40mm (Hi-Flow) ₹ 4550/-
CAM-DIV05 - 45mm (Hi-Flow) ₹ 5330/-
CAM-930 Concealed Body
Wall Mixer Complete ₹ 7255/-
CAM-64 S/L Wall Mounted
Basin Mixer ₹ 6405/-
CAM-67 Swan Neck
Colour Spout ₹ 2640/-

CAM-66 Sink Cock Colour Spout ₹ 2340/-
CAM-42 Center Hole Quarter Turn ₹ 4480/-
CAM-43 Sink Mixer ₹ 4635/-
CAM-61 Plain Spout ₹ 1145/-
CAM-60 Tip Ton Spout ₹ 1590/-
CAM-44 Non Telephonic ₹ 4635/-
CAM-EXP-01 Single Lever Diverter Exposed Parts ₹ 1885/-

CAM-47 Single Lever Basin Mixer ₹ 5600/-
CAM-901 Swan Neck Extra Big Round Spout ₹ 2800/-
CAM-903 Sink Cock Extended Spout ₹ 2275/-
CAM-902 Sink Cock Extra Big Round Spout ₹ 2645/-
CAM-14 Flush Cock 1" Light Casted Body ₹ 1650/-
CAM-916P Wall Mixer with Bend Product ₹ 5135/-
CAM-58 Single Lever Basin Mixer 12" Long ₹ 5650/-



FL-47
Single Lever Basin Mixer
₹ 4745/-



FL-48
Single Lever Basin Mixer
12" Long ₹ 5650/-



FL-42
Center Hole Quarter Turn
₹ 4920/-



FL-16
Pillar Cock 12" Tall
₹ 3680/-



FL-901
Swan Neck Extra Big Round Spout
₹ 3595/-



FL-11
Pillar Cock
₹ 1875/-



FL-21
Bib Cock
₹ 1615/-



FL-22
Long Nose
₹ 1980/-



FL-67
2-in-1 Single Lever Bib Cock
₹ 2595/-



FL-29
2-in-1 Angle Valve
₹ 2750/-



FL-27
Angle Valve
₹ 1465/-



Concealed Stop Cock
(Fitting 20mm)
FL-12 - 15mm • ₹ 1875/-
FL-12A - 20mm • ₹ 1910/-



FL-23
Flush Cock 1" Medium
Forged Body
₹ 1620/-



FL-24
Flush Cock 1" Heavy
₹ 2800/-



FL-61
Plain Spout
₹ 1400/-



FL-60
Tipton Spout
₹ 1980/-



Single Lever Diverter Complete
FL-56 - 40mm (Normal) ₹ 5880/-
FL-59 - 40mm (Hi-Flow) ₹ 6435/-
FL-45 - 45mm (Hi-Flow) ₹ 7215/-



FL-35
Swan Neck (J Spout)
₹ 2875/-



FL-35EX
Swan Neck Extended Spout
₹ 3335/-



FL-34
Sink Cock (J Spout)
₹ 2470/-



FL-34EX
Sink Cock (Extended Spout)
₹ 3035/-



FL-58
Single Lever Sink Mixer
(Table Mounted) ₹ 5565/-



FL-68
Wall Mounted Basin Tap
Complete ₹ 4145/-



FL-40EH
Wall Mixer with L-Bend Extra Heavy
₹ 7525/-



FL-41
3-in-1 Wall Mixer with L-Bend
₹ 7800/-



FL-40
Wall Mixer with L-Bend
₹ 7175/-



FL-43
Sink Mixer
₹ 5850/-



FLCWM-930
Concealed Body Wall Mixer
Complete ₹ 7255/-



FL-902
Sink Cock Extra
Big Round Spot ₹ 3145/-



FL-43EX
Sink Mixer (Extended Spout)
₹ 6210/-

FL-20
Nozzle Bib Cock
₹ 1795/-

FL-28
Washing Machine Tap
₹ 1795/-

FL-14
Flush Cock 1"
Light Casted Body
₹ 1620/-

FL-44
Non Telephonic
₹ 5770/-

FL-23
Flush Cock 1"
Medium Forged Body
₹ 1620/-

FL-EXP-01
S/L Diverter Exposed
Parts ₹ 1885/-

Single Lever Diverter Body & Fitting
FL-Div01 - 40mm (Normal) ₹ 3995/-
FL-Div02 - 40mm (Hi-Flow) ₹ 4550/-
FL-Div05 - 45mm (Hi-Flow) ₹ 5330/-



FL-47
Single Lever Basin Mixer
₹ 4830/-



FL-48
Single Lever Basin Mixer
12" Long ₹ 5735/-



FL-42
Center Hole Quarter Turn
₹ 5090/-



FL-16
Pillar Cock 12" Tall
₹ 3765/-



FL-901
Swan Neck Extra Big Round Spout
₹ 3680/-



FL-11
Pillar Cock
₹ 1960/-



FL-21
Bib Cock
₹ 1700/-



FL-22
Long Nose
₹ 2065/-



FL-67
2-in-1 Single Lever Bib Cock
₹ 2680/-



FL-29
2-in-1 Angle Valve
₹ 2920/-



FL-27
Angle Valve
₹ 1550/-



Concealed Stop Cock
(Fitting 20mm)
FL-12 - 15mm • ₹ 1875/-
FL-12A - 20mm • ₹ 1910/-



FL-23
Flush Cock 1" Medium
Forged Body
₹ 1705/-



FL-24
Flush Cock 1" Heavy
₹ 2885/-



FL-61
Plain Spout
₹ 1400/-



FL-60
Tipton Spout
₹ 1980/-



Single Lever Diverter Complete
FL-56 - 40mm (Normal) ₹ 5880/-
FL-59 - 40mm (Hi-Flow) ₹ 6435/-
FL-45 - 45mm (Hi-Flow) ₹ 7215/-



FL-35
Swan Neck (J Spout)
₹ 2960/-



FL-35EX
Swan Neck Extended Spout
₹ 3420/-



FL-34
Sink Cock (J Spout)
₹ 2555/-



FL-34EX
Sink Cock (Extended Spout)
₹ 3120/-



FL-58
Single Lever Sink Mixer
(Table Mounted) ₹ 5650/-



FL-68
Wall Mounted Basin Tap
Complete ₹ 4230/-



FL-40EH
Wall Mixer with L-Bend Extra Heavy
₹ 7780/-



FL-41
3-in-1 Wall Mixer with L-Bend
₹ 8115/-



FL-40
Wall Mixer with L-Bend
₹ 7430/-



FL-43
Sink Mixer
₹ 6020/-



FLCWM-930
Concealed Body Wall Mixer
Complete ₹ 7510/-



FL-902
Sink Cock Extra
Big Round Spot ₹ 3230/-



FL-43EX
Sink Mixer (Extended Spout)
₹ 6380/-

FL-20
Nozzle Bib Cock
₹ 1880/-

FL-28
Washing Machine Tap
₹ 1880/-

FL-14
Flush Cock 1"
Light Casted Body
₹ 1705/-

FL-44
Non Telephonic
₹ 5940/-

FL-23
Flush Cock 1"
Medium Forged Body
₹ 1705/-

FL-EXP-01
S/L Diverter Exposed
Parts ₹ 1885/-

Single Lever Diverter Body & Fitting
FL-Div01 - 40mm (Normal) ₹ 3995/-
FL-Div02 - 40mm (Hi-Flow) ₹ 4550/-
FL-Div05 - 45mm (Hi-Flow) ₹ 5330/-



FP-47
Single Lever Basin Mixer
₹ 4745/-



FP-40
Wall Mixer with L-Bend
₹ 7175/-



FP-40 EH
Wall Mixer with L-Bend Extra Heavy
₹ 7525/-



FP-11
Pillar Cock
₹ 1875/-



FP-21
Bib Cock
₹ 1615/-



FP-22
Long Nose
₹ 1980/-



FP-26
2-in-1 Bib Cock
₹ 2595/-



FP-27
Angle Valve
₹ 1465/-



FP-29
2-in-1 Angle Valve
₹ 2750/-



FP-24
Flush Cock 1" Heavy
₹ 2800/-



FP-23
Flush Cock 1" Medium
Forged Body ₹ 1620/-



Concealed Stop Cock (Fitting 20mm)
FP-12 - 15mm (Side) ₹ 1875/-
FP-12A - 20mm (Side) ₹ 1910/-



FP-16
Pillar Cock 12" Tall
₹ 3680/-



FP-35
Swan Neck (J. Spout)
₹ 2875/-



FP-48
Single Lever Basin Mixer
12" Long ₹ 5650/-



FP-34
Sink Cock (J Spout)
₹ 2470/-



FP-43
Sink Mixer
₹ 5850/-

FP-14
Flush Cock 1" Light
Casted Body ₹ 1620/-

FP-20
Nozzle Bib Cock
₹ 1795/-

FP-28
Washing Machine Tap
₹ 1795/-

FP-35EX
Swan Neck Extended
Spout ₹ 3335/-

FP-41
3 in 1 Wall Mixer
with Blend ₹ 7860/-

FP-EXP-01
S/L Diverter Exposed Parts
₹ 1885/-

Single Lever Diverter Complete
FP-56 - 40mm (Normal) ₹ 5880/-
FP-59 - 40mm (Hi-Flow) ₹ 6435/-
FP-56 - 45mm (Hi-Flow) ₹ 7215/-

FP-42
Basin Mixer Quarter Turn
₹ 4920/-

FP-901
Swan Neck (Big Round
Spout) ₹ 3595/-

FP-902
Sink Cock with Big
Round Spout ₹ 3145/-

FP-903
Sink Cock Extended
Spout ₹ 3035/-



CA-42
Basin Mixer Quarter Turn
₹ 4170/-



CA-11
Pillar Cock
₹ 1380/-



CA-904
Pillar Cock Extra Big Long Height & Long Nose
₹ 1705/-



CA-21
Bib Cock
₹ 1185/-



CA-22
Long Nose
₹ 1355/-



CA-27
Angle Valve
₹ 1015/-



CA-29
2-in-1 Angle Valve
₹ 2045/-



CA-26
2-in-1 Bib Cock
₹ 2045/-



Concealed Stop Cock (Fitting 15mm)
CA-31 - 15mm ₹ 1560/-
CA-32 - 20mm ₹ 1560/-



CA-23
Flush Cock 1" Medium Forged Body
₹ 1725/-



CA-14
Flush Cock 1" Light Casted Body
₹ 1725/-



Single Lever Diverter Complete
CA-56 - 40mm (Normal) ₹ 5880/-
CA-59 - 40mm (Hi-Flow) ₹ 6435/-
CA-56 - 45mm (Hi-Flow) ₹ 7215/-



CA-24
Flush Cock 1" Heavy
₹ 2880/-



CA-16
Pillar Cock 12" Tall
₹ 3040/-



CA-35
Swan Neck (J. Spout)
₹ 1960/-



CA-34
Sink Cock (J Spout)
₹ 1840/-



CA-43
Sink Mixer
₹ 4295/-



CA-40
Wall Mixer with L-Bend
₹ 5730/-

Concealed StopCock (Fitting 20mm)
CA-12 - 15mm ₹ 1950/-
CA-12A - 20mm ₹ 1980/-

CA-20
Nozzle Bib Cock
₹ 1270/-

CA-28
Washing Machine Tap
₹ 1270/-

CA-27P
Angle Valve Project
₹ 930/-

CA-907
Pillar Cock 9"
₹ 2685/-

CA-901
Swan Neck Big Round
Spout ₹ 2475/-

Single Lever Diverter Body & Fitting
CA-DIV01 - 40mm (Normal) ₹ 3995/-
CA-DIV02 - 40mm (Hi-Flow) ₹ 4550/-
CA-DIV03 - 40mm (Hi-Flow) ₹ 5330/-

CA-41
3 in 1 Wall Mixer
with Bend ₹ 7075/-

CA-60
Tipton Spout
₹ 1635/-

CA-61
Plain Spout
₹ 1145/-

CA-66
Sink Cock Coloured
Spout ₹ 2035/-

CA-67
Swan Neck Coloured
Spout ₹ 2165/-

CA-902
Sink Cock Extra Big
Round Spout ₹ 2385/-

CA-903
Swan Cock Extended
Spout ₹ 2010/-

CA-EXP-01 Single Lever Diverter
Exposed Parts ₹ 1885/-



EV-42
Basin Mixer Quarter Turn
₹ 3870/-



EV-16
Pillar Cock 12" Tall
₹ 2960/-



Note :
MOQ - 80 Pcs
EV-916P
Wall Mixer with Bend Project
₹ 4970/-



Note :
30mm Cartridge
for smooth flow
EV-40
Wall Mixer with L-Bend
₹ 5450/-



EV-41
3-in-1 Wall Mixer with L-Bend
₹ 6430/-



EV-13
Pillar Cock High Neck
₹ 2305/-



EV-11
Pillar Cock
₹ 1315/-



EV-904
Pillar Cock Extra Heavy
Long Height & Long Nose
₹ 1810/-



EV-35
Swan Neck (J. Spout)
₹ 1880/-



EV-26
2-in-1 Bib Cock
₹ 1995/-



EV-20
Nozzle Bib Cock
₹ 1215/-



EV-28
Washing Machine Tap
₹ 1215/-



EV-29
2-in-1 Angle Valve
₹ 2025/-



EV-27
Angle Valve
₹ 1040/-



EV-27P
Angle Valve (Project)
₹ 930/-



EV-21P
Bib Cock (Project)
₹ 930/-



EV-21
Bib Cock
₹ 1040/-



EV-22
Long Nose (Extra Long)
₹ 1180/-



EV-14
Flush Cock (Light)
Casted Body
₹ 1635/-



EV-23
Flush Cock 1" Medium
Forged Body SS-304
₹ 1635/-



Concealed Stop Cock
(Fitting 15mm)
EV-31 - 15mm ₹ 1490/-
EV-32 - 20mm ₹ 1530/-



Concealed Stop Cock
(Fitting 20mm)
EV-12 - 15mm ₹ 1745/-
EV-12A - 20mm ₹ 1785/-



EV-24
Flush Cock 1" Heavy
₹ 2880/-



EV-60
Tipton Spout
₹ 1470/-



EV-61
Plain Spout
₹ 1030/-



EV-68
Wall Mounted Basin Tap
Complete ₹ 4100/-



EV-34
Sink Cock (J Spout)
₹ 1745/-



EV-903
Sink Cock Extended Spout
₹ 2010/-



EV-43
Sink Mixer
₹ 3980/-



Single Lever Diverter Complete
EV-56 - 40mm (Normal) ₹ 5880/-
EV-59 - 40mm (Hi-Flow) ₹ 6435/-
EV-45 - 45mm (Hi-Flow) ₹ 7215/-



EV-44
Wall Mixer Non-Telephonic
₹ 4200/-



EV-67
Swan Neck Coloured Spout
₹ 2165/-



EV-907
Pillar Cock 9"
₹ 2660/-



EV-66
Sink Cock Flexible Colour Spout
₹ 2035/-

Single Lever Diverter Body & Fitting
EV-DIV01 - 40mm (Normal) ₹ 3995/-
EV-DIV05 - 45mm (Hi-Flow) ₹ 5330/-

EV-DIV02 - 40mm (Hi-Flow) ₹ 4550/-

EV-EXP-01 Single Lever Diverter Exposed Parts ₹ 1885/-

EV-48 Single Lever Basin Mixer 12" Long ₹ 5650/-

EV-47 Single Lever Basin Mixer ₹ 3840/-



RO-42
Basin Mixer Quarter Turn
₹ 3870/-



RO-40
Wall Mixer with L-Bend
₹ 5450/-



RO-41
3-in-1 Wall Mixer with L-Bend
₹ 6430/-



RO-11
Pillar Cock
₹ 1520/-



RO-22
Long Nose
₹ 1360/-



RO-21
Bib Cock
₹ 1165/-



RO-26
2-in-1 Bib Cock
₹ 2045/-



RO-27
Angle Valve
₹ 965/-



Concealed Stop Cock
(Fitting 20mm)
RO-12 - 15mm • ₹ 1745/-
RO-12A - 20mm • ₹ 1785/-



RO-60
Tip Ton Spout
₹ 1635/-



RO-61
Plain Spout
₹ 1145/-



RO-14
Flush Cock (Light)
Casted Body
₹ 1635/-



RO-23
Flush Cock 1" Medium
Forged Body
₹ 1635/-



RO-24
Flush Cock 1" Heavy
Casted Body
₹ 2880/-



Single Lever Diverter Complete
RO-56 - 40mm (Normal) | ₹ 5880/-
RO-59 - 40mm (Hi-Flow) | ₹ 6435/-
RO-45 - 45mm (Hi-Flow) | ₹ 7215/-



RO-16
Pillar Cock 12" Tall
₹ 2960/-



RO-35
Swan Neck (J. Spout)
₹ 1875/-



RO-34
Sink Cock (J Spout)
₹ 1745/-



RO-43
Sink Mixer
₹ 3980/-

Concealed StopCock Fitting 15mm
RO-31 - 15mm ₹ 1485/-
RO-32 - 20mm ₹ 1530/-

RO-66
Sink Cock Colour
Spout ₹ 2135/-

RO-67
Swan Neck Colour
Spout ₹ 2270/-

RO-901
Swan Neck Extra Big
Round Spout ₹ 2475/-

RO-902
Sink Cock Extra Big
Round Spout ₹ 2385/-

Single Lever Diverter Body & Fitting
RO-DIV-01 - 40mm (Normal) ₹ 3995/-
RO-DIV-02 - 40mm (Hi-Flow) ₹ 4550/-
RO-DIV-05 - 45mm (Hi-Flow) ₹ 5330/-

RO-29
2-in-1 Angle Valve
₹ 2100/-

RO-EXP-01
S/L Diverter Exposed Parts
₹ 1885/-

RO-903
Sink Cock Extended
Spout ₹ 2010/-



CVB-35
Swan Neck (J. Spout)
₹ 2140/-



CVB-40
Wall Mixer with Bend / Crutch
₹ 5595/-



CVB-41
3-in-1 Wall Mixer with L-Bend
₹ 6640/-



CVB-21
Bib Cock
₹ 1030/-



CVB-22
Long Body / Long Nose
₹ 1225/-



CVB-11
Pillar Cock Foam Flow
₹ 1390/-



CVB-26
2-in-1 Bib Cock
₹ 1990/-



CVB-27
Angle Valve
₹ 995/-



CVB-29
2-in-1 Angle Valve
₹ 2040/-



Concealed Stop Cock (Fitting 15mm)
CVB-31 - 15mm | ₹ 1460/-
CVB-32 - 20mm | ₹ 1490/-



CVB-14
Flush Cock 1" Light Casted & Body
₹ 1650/-



CVB-23
Flush Cock 1" Medium Forged Body
₹ 1650/-



CVB-34
Sink Cock (J. Spout)
₹ 2015/-

Single Lever Diverter Complete
CVB-56 - 40mm (Normal) ₹ 5880/-
CVB-59 - 40mm (Hi-Flow) ₹ 6435/-
CVB-45 - 45mm (Hi-Flow) ₹ 7215/-
Concealed Stop Cock (Fitting 20mm)
CVB-12 - 15mm ₹ 1720/-
CVB-12A - 20mm ₹ 1750/-
CVB-13 Pillar Cock Hi-Neck ₹ 2415/-
CVB-58 S/L Sink Mixer Table Mounted ₹ 5200/-

CVB-930 Concealed Body
Wall Mixer Complete ₹ 7255/-
CVB-48 S/L Basin Mixer 12"
₹ 5875/-
CVB-16 Pillar Cock 12"
₹ 2905/-

CVB-61 Plain Spout ₹ 1145/-
CVB-60 Tip Ton Spout ₹ 1635/-
CVB-24 Flush Cock 1"
Heavy ₹ 2860/-

CVB-66 Sink Cock Coloured Spout ₹ 2135/-
CVB-67 Swan Neck Cock Coloured Spout ₹ 2270/-
CVB-47 Single Lever Basin Mixer ₹ 4070/-
CVB-901 Swan Neck Extra Big Round Spout ₹ 2780/-
CVB-902 Sink Cock Extra Big Round Spout ₹ 2660/-
CVB-903 Sink Cock Extended Spout ₹ 2300/-
CVB-EXP-01 Single Lever Diverter Exposed Parts ₹ 1885/-

Note : The above range comes without wall flange.



OPP-40
Wall Mixer with L-Bend
₹ 6650/-



OPP-47
Single Lever Basin Mixer
₹ 3775/-



OPP-64
S/L Wall Mounted Basin Mixer
₹ 6405/-



OPP-11
Pillar Cock
₹ 2300/-



OPP-21
Bib Cock
₹ 1530/-



OPP-22
Long Body / Long Nose
₹ 2035/-



OPP-26
2-in-1 Bib Cock
₹ 2595/-



OPP-27
Angle Valve
₹ 1305/-



OPP-29
2-in-1 Angle Valve
₹ 2595/-



Single Lever Diverter Complete
OPP-56 - 40mm (Normal) ₹ 5880/-
OPP-59 - 40mm (Hi-Flow) ₹ 6435/-
OPP-45 - 45mm (Hi-Flow) ₹ 7215/-



OPP-60
Tip Ton Spout
₹ 2870/-



OPP-61
Plain Spout
₹ 2145/-



Concealed Stop Cock (Fitting 20mm)
OPP-12 - 15mm ₹ 1875/-
OPP-12A - 20mm ₹ 1910/-



OPP-16
Pillar Cock 12" Tall
₹ 3970/-



OPP-24
Flush Cock 1" Heavy
₹ 2800/-



OPP-35
Swan Neck (J Spout)
₹ 2670/-



OPP-34
Sink Cock (J Spout)
₹ 2435/-

OPP-41
3 in 1 Wall Mixer
with Bend ₹ 7615/-

OPP-43
Sink Mixer
₹ 4925/-

OPP-EXP-01
S/L Diverter Exposed Parts
₹ 1885/-

S/L Diverter Body & Fitting
OPP-DIV-01 - 40mm (Normal) ₹ 3995/-
OPP-DIV-02 - 40mm (Hi-Flow) ₹ 4550/-
OPP-DIV-05 - 45mm (Hi-Flow) ₹ 5330/-



AV-47
Single Lever Basin Mixer
₹ 4745/-



AV-21
Bib Cock
₹ 1535/-

AV-60
Tip Ton Spout
₹ 2140/-

AV-61
Plain Spout
₹ 1580/-

AV-11
Pillar Cock
₹ 1790/-

AV-22
Long Nose
₹ 1780/-

AV-26
2-in-1 Bib Cock
₹ 2595/-

AV-27
Angle Valve
₹ 1305/-

AV-29
2-in-1 Angle Valve
₹ 2595/-

AV-64
Wall Mounted Basin Mixer
₹ 7010/-

AV-68
Wall Mounted Basin Tap
Complete ₹ 4510/-



AV-42
Basin Mixer Quarter Turn
₹ 4030/-



Concealed Stop Cock
(Fitting 15mm)
AV-31 - 15mm | ₹ 1690/-
AV-32 - 20mm | ₹ 1725/-



Concealed Stop Cock
(Fitting 20mm)
AV-12 - 15mm | ₹ 1775/-
AV-12A - 20mm | ₹ 1810/-



AV-24
Flush Cock 1" Heavy
₹ 2800/-



AV-23
Flush Cock 1" Medium
Forged Body
₹ 1620/-



AV-16
Pillar Cock 12" Tall
₹ 2905/-



AV-35
Swan Neck (J Spout)
₹ 2615/-



AV-33
Swan Neck (Casted Spout)
₹ 3660/-



AV-903
Sink Cock Extended Spout
₹ 2650/-



AV-34
Sink Cock (J Spout)
₹ 2390/-



AV-48
Single Lever Basin Mixer
12" Long ₹ 5875/-



Single Lever Diverter Complete
AV-56 - 40mm (Normal) | ₹ 5880/-
AV-59 - 40mm (Hi-Flow) | ₹ 6435/-
AV-45 - 45mm (Hi-Flow) | ₹ 7215/-



AVCWM-930
Concealed Body Wall Mixer
Complete
₹ 7255/-



AV-43
Sink Mixer
₹ 4910/-



AV-51
Sink Mixer (Casted Spout)
₹ 5880/-



AV-44
Wall Mixer Non-Telephonic
₹ 4910/-



AV-901
Swan Neck Extra Big Round
Spout ₹ 3140/-



AV-902
Sink Cock Extra Big Round
Spout ₹ 3025/-



AV-40
Wall Mixer with L-Bend
₹ 6415/-



AV-41
3-in-1 Wall Mixer with L-Bend
₹ 7200/-



AV-30
Sink Cock (Casted Spout)
₹ 3405/-

AV-14
Flush Cock 1" Light Casted Body
₹ 1620/-

AV-66
Sink Cock Coloured Spout
₹ 2460/-

AV-67
Swan Neck Coloured Spout
₹ 2520/-

AV-EXP-01 -
S/L Diverter Exposed Parts
₹ 1885/-

Single Lever Diverter Body & Fitting
AV-DIV01 - 40mm (Normal) • ₹ 3995/-
AV-DIV02 - 40mm (Hi-Flow) • ₹ 4550/-
AV-DIV05 - 45mm (Hi-Flow) • ₹ 5330/-



TO-42
Basin Mixer Quarter Turn
₹ 3445/-



TO-40
Wall Mixer with L-Bend
₹ 5175/-



TO-41
3-in-1 Wall Mixer with L-Bend
₹ 6100/-



TO-11
Pillar Cock
₹ 1040/-



TO-21
Bib Cock
₹ 935/-



TO-22A
Long Body
₹ 1040/-



TO-26
2-in-1 Bib Cock
₹ 1960/-



TO-27
Angle Valve
₹ 935/-



TO-29
2-in-1 Angle Valve
₹ 1960/-



TO-28
Washing Machine Tap
₹ 1190/-



TO-20
Nozzle Bib Cock
₹ 1190/-



Concealed Stop Cock
(Fitting 15mm)
TO-31 - 15mm • ₹ 1490/-
TO-32 - 20mm • ₹ 1490/-



Concealed Stop Cock
(Fitting 20mm)
TO-12 - 15mm • ₹1695/-
TO-12A - 20mm • ₹1725/-



TO-23
Flush Cock 1" Medium
Forged Body ₹ 1620/-



TO-34
Sink Cock (J Spout)
₹ 1750/-



TO-35
Swan Neck (J Spout)
₹ 1900/-



TO-43
Sink Mixer
₹ 3675/-



TO-44
Non-Telephonic
₹ 3675/-

TO-14
Flush Cock 1" Light Casted Body
₹ 1620/-

TO-24
Flush Cock 1" Heavy
₹ 2800/-



NE-42
Center Hole (Quarter Turn)
₹ 3990/-



NE-13
Pillar Cock High Neck
₹ 2205/-



NE-11
Pillar Cock
₹ 1200/-



NE-21
Bib Cock
₹ 1070/-



NE-22
Long Body
₹ 1185/-



NE-26
2-in-1 Bib Cock
₹ 1925/-



NE-27
Angle Valve
₹ 1070/-



NE-29
2-in-1 Angle Valve
₹ 2165/-



NE-28
Washing Machine Tap
₹ 1220/-



NE-20
Nozzle Bib Cock
₹ 1220/-



Concealed Stop Cock
NE-31 - 15mm • ₹ 1555/-
NE-32 - 20mm • ₹ 1590/-



NE-14
Flush Cock (Light)
Casted Body
₹ 1620/-



NE-24
Flush Cock 1" Heavy
₹ 2800/-



NE-23
Flush Cock 1" Medium
Forged Body
₹ 1620/-



NE-76
Stop Cock 1/2"
₹ 1070/-



NE-77
Stop Cock 3/4"
₹ 1100/-



NE-35
Swan Neck (J Spout)
₹ 2145/-



NE-30
Sink Cock (Casted Spout)
₹ 2480/-



NE-34
Sink Cock (J Spout)
₹ 1840/-



NE-43
Sink Mixer
₹ 4115/-



NE-40
Wall Mixer with L-Bend
₹ 5590/-



NE-41
3-in-1 Wall Mixer with L-Bend
₹ 7245/-



FC-42
Basin Mixer Quarter Turn
₹ 3405/-



FC-11
Pillar Cock
₹ 1060/-



FC-27
Angle Valve
₹ 510/-



FC-21
Bib Cock
₹ 825/-



FC-22
Long Nose
₹ 885/-



FC-26
2-in-1 Bib Cock
₹ 1470/-



FC-61
Plain Spout
₹ 1030/-



FC-40
Wall Mixer with L-Bend / Crutch
₹ 4595/-



Concealed Stop Cock
(Fitting 15mm)
FC-31 - 15mm • ₹ 1330/-
FC-32 - 20mm • ₹ 1330/-



FC-14
Flush Cock 1" Light
Casted Body
₹ 1620/-



FC-29
2-in-1 Angle Valve
₹ 1705/-



FC-34
Sink Cock (J Spout)
₹ 1495/-



FC-35
Swan Neck (J Spout)
₹ 1615/-



FC-43
Sink Mixer
₹ 3625/-

FC-41 3 in 1 Wall Mixer with Bend ₹ 5685/-



AS-47
Single Lever Basin Mixer
₹ 4745/-



AS-48
Single Lever Basin Mixer
12" Long ₹ 5875/-



AS-42
Center Hole Quarter Turn
₹ 4005/-



AS-64
Single Lever Basin Mixer Wall
Mounted ₹ 6405/-



AS-13
Pillar Cock Hi-Neck
₹ 2535/-



AS-11
Pillar Cock
₹ 1790/-



AS-23
Flush Cock 1" Medium
Forged Body ₹ 1750/-



AS-21
Bib Cock
₹ 1390/-



AS-22
Long Nose
₹ 1580/-



AS-26
2-in-1 Bib Cock
₹ 2595/-



AS-29
2-in-1 Angle Valve
₹ 2595/-



AS-27
Angle Valve
₹ 1305/-



AS-24
Flush Cock 1" Heavy
₹ 2800/-



Single Lever Diverter Complete
AS-56 - 40mm (Normal) ₹ 5880/-
AS-59 - 40mm (Hi-Flow) ₹ 6435/-
AS-45 - 45mm (Hi-Flow) ₹ 7215/-



AS-60
Tip Ton Spout
₹ 1980/-



AS-61
Plain Spout
₹ 1400/-



ASCWM-930
Concealed Body Wall Mixer
Complete ₹ 7255/-



AS-35
Swan Neck (J Spout)
₹ 2615/-



AS-34
Sink Cock (J Spout)
₹ 2390/-



AS-903
Sink Cock Extended Spout
₹ 2650/-



AS-43
Sink Mixer
₹ 4910/-



AS-44
Wall Mixer Non Telephonic
₹ 4910/-



AS-901
Swan Neck Extra Big Round
Spout ₹ 3140/-



AS-902
Sink Cock Extra Big Round
Spout ₹ 3025/-



AS-16
Pillar Cock 12" Tall
₹ 3745/-



AS-40
Wall Mixer with L-Bend
₹ 6305/-



AS-41
3-in-1 Wall Mixer with L-Bend
₹ 7120/-

AS-66
Sink Cock Coloured Spout ₹ 2460/-

AS-67
Swan Neck Cock Coloured Spout ₹ 2640/-

Concealed Stop Cock (Fitting 20mm)
AS-12 - 15mm ₹ 1775/-
AS-12A - 20mm ₹ 1810/-

AS-EXP-01
S/L Diverter Exposed Parts ₹ 1885/-
Concealed Stop Cock (Fitting 15mm)
AS-31 - 15mm ₹ 1690/-
AS-32 - 20mm ₹ 1725/-

S/L Diverter Body & Fitting
AS-DIV-01 - 40mm (Normal) ₹ 3995/-
AS-DIV-02 - 40mm (Hi-Flow) ₹ 4550/-
AS-DIV-03 - 45mm (Hi-Flow) ₹ 5330/-



AD-47
Single Lever Basin Mixer
₹ 3775/-



AD-904
Pillar Cock Extra Heavy
₹ 1750/-



AD-11
Pillar Cock
₹ 1255/-



AD-21
Bib Cock
₹ 960/-



AD-22
Long Nose
₹ 1100/-



AD-21P
Bib Cock Project
₹ 860/-



AD-26
2-in-1 Bib Cock
₹ 1915/-



AD-27
Angle Valve
₹ 965/-



AD-29
2-in-1 Angle Valve
₹ 1915/-



AD-20
Nozzle Bib Cock
₹ 960/-



Single Lever Diverter Complete
AD-56 - 40mm (Normal) ₹ 5880/-
AD-59 - 40mm (Hi-Flow) ₹ 6435/-
AD-45 - 45mm (Hi-Flow) ₹ 7215/-



ADCWM-930
Concealed Wall Mixer Complete
₹ 7000/-



Concealed Stop Cock
(Fitting 15mm)
AD-31 - 15mm • ₹ 1440/-
AD-32 - 20mm • ₹ 1475/-



Concealed Stop Cock
(Fitting 20mm)
AD-12 - 15mm • ₹ 1695/-
AD-12A - 20mm • ₹ 1725/-



AD-14
Flush Cock 1" Light
Casted Body
₹ 1620/-



AD-23
Flush Cock 1" Medium
Forged Body
₹ 1620/-



AD-42
Center Hole Quarter Turn
₹ 3650/-



AD-907
Pillar Cock 9"
₹ 2610/-



AD-35
Swan Neck (J Spout)
₹ 1825/-



AD-34
Sink Cock (J Spout)
₹ 1665/-



AD-902
Sink Cock Extra Big Round Spout
₹ 2305/-



AD-903
Sink Cock Extended Spout
₹ 1930/-



AD-48
Single Lever Basin Mixer 12" Long
₹ 5650/-



AD-901
Swan Neck Extra Big Round Spout
₹ 2420/-



AD-16
Pillar Cock 12" Tall
₹ 2905/-



AD-40
Wall Mixer with L-Bend / Crutch
₹ 5450/-

AD-13
Pillar Cock Hi Neck
₹ 2250/-

AD-27P
Angle Valve Project
₹ 860/-

AD-41
3 in 1 Wall Mixer with Bend
₹ 6300/-

AD-43
Sink Mixer
₹ 3870/-

AD-44
Non Telephonic
₹ 3870/-



AI-47
Single Lever Basin Mixer
₹ 4070/-



AI-40
Wall Mixer with L-Bend / Crutch
₹ 6475/-



AI-41
3-in-1 Wall Mixer with Bend
₹ 6865/-



AI-48
Single Lever Basin
Mixer 12" Long ₹ 5875/-



AI-16
Pillar Cock 12" Tall
₹ 3485/-



AI-11
Pillar Cock
₹ 1780/-



AI-21
Bib Cock
₹ 1460/-



AI-22
Long Nose
₹ 1625/-



AI-26
2-in-1 Bib Cock
₹ 2565/-



AI-27
Angle Valve
₹ 1385/-



AI-29
2-in-1 Angle Valve
₹ 2565/-



Single Lever Diverter Complete
AI-56 - 40mm (Normal) • ₹ 5880/-
AI-59 - 40mm (Hi-Flow) • ₹ 6435/-
AI-45 - 45mm (Hi-Flow) • ₹ 7215/-



AI-60
Tip Ton Spout
₹ 2375/-



AI-61
Plain Spout
₹ 1685/-



Concealed Stop Cock
(Fitting 15mm)
AI-31 - 15mm • ₹ 1575/-
AI-32 - 20mm • ₹ 1610/-



Concealed Stop Cock
(Fitting 20mm)
AI-12 - 15mm • ₹ 1655/-
AI-12A - 20mm • ₹ 1690/-



AI-24
Flush Cock 1" Heavy
₹ 2800/-



AI-35
Swan Neck (J Pipe Spout)
₹ 2620/-



AI-901
Swan Neck Extra Big
Round Spout ₹ 3230/-



AI-43
Sink Mixer
₹ 4470/-



AI-34
Sink Cock (J Pipe Spout)
₹ 2225/-



AI-902
Sink Cock Extra Big
Round Spot ₹ 2815/-



AI-903
Sink Cock Extended Spout
₹ 2475/-

AI-14
Flush Cock 1" Light
Casted Body ₹ 1555/-

AI-23
Flush Cock 1" Medium
Forged Body ₹ 1810/-

AI-66
Sink Cock Coloured
Spout ₹ 2460/-

AI-67
Swan Neck Coloured
Spout ₹ 2640/-

AI-EXP-01
S/L Diverter Exposed Parts
₹ 1885/-

Single Lever Diverter Body & Fitting
AI-DIV01 - 40mm (Normal) • ₹ 3995/-
AI-DIV02 - 40mm (Hi-Flow) • ₹ 4550/-
AI-DIV05 - 45mm (Hi-Flow) • ₹ 5330/-



AI-RG-47
Single Lever Basin Mixer
₹ 7925/-



AI-RG-16
Pillar Cock 12" Tall
₹ 6010/-



AI-RG-48
Single Lever Basin Mixer 12" Long
₹ 10055/-



AI-RG-13
Pillar Cock High Neck
₹ 3550/-



AI-RG-11
Pillar Cock
₹ 2810/-



AI-RG-21
Bib Cock
₹ 2760/-



AI-RG-22
Long Body / Long Nose
₹ 2920/-



AI-RG-26
2-in-1 Bib Cock
₹ 4440/-



AI-RG-27
Angle Valve
₹ 2235/-



AI-RG-35
Swan Neck
₹ 4385/-



Single Lever Diverter Complete
AI-RG-56 - 40mm (Normal) ₹ 8020/-
AI-RG-59 - 40mm (Hi-Flow) ₹ 8575/-
AI-RG-45 - 45mm (Hi-Flow) ₹ 9355/-



AI-RG-61
Plain Spout
₹ 2865/-



AI-RG-60
Tip Ton Spout
₹ 4440/-



AI-RG-34
Sink Cock
₹ 4010/-



AI-RG-43
Sink Mixer
₹ 7305/-



AI-RG-40
Wall Mixer with L-Bend
₹ 11685/-



AI-RG-41
3-in-1 Wall Mixer with L-Bend
₹ 13250/-

AI-RG-29
2-in-1 Angle Valve
₹ 4440/-

Single Lever Diverter Body & Fitting
AI-RG-DIV01 - 40mm (Normal) • ₹ 3995/-
AI-RG-DIV02 - 40mm (Hi-Flow) • ₹ 4550/-
AI-RG-DIV05 - 45mm (Hi-Flow) • ₹ 5330/-

AI-RG-31
Concealed Stop Cock 15mm
₹ 2670/-

AI-RG-EXP-01
S/L Diverter Exposed Parts
₹ 4025/-

AI-RG-64
S/L Wall Mounted Basin Mixer
₹ 10175/-



AI-BL-47
Single Lever Basin Mixer
₹ 7925/-



AI-BL-48
Single Lever Basin Mixer 12" Long
₹ 10055/-



AI-BL-16
Pillar Cock 12" Tall
₹ 6010/-



AI-BL-11
Pillar Cock
₹ 2810/-



AI-BL-21
Bib Cock
₹ 2760/-



AI-BL-22
Long Body / Long Nose
₹ 2920/-



AI-BL-26
2-in-1 Bib Cock
₹ 4440/-



AI-BL-60
Tip Ton Spout
₹ 4440/-



AI-BL-61
Plain Spout
₹ 2865/-



AI-BL-34
Sink Cock
₹ 4010/-



AI-BL-35
Swan Neck
₹ 4385/-



AI-BL-40
Wall Mixer with L-Bend
₹ 11685/-



AI-BL-41
3-in-1 Wall Mixer with L-Bend
₹ 13250/-

AI-BL-13
Pillar Cock High Neck
₹ 3350/-

AI-BL-27
Angle Valve
₹ 2235/-

AI-BL-29
2-in-1 Angle Valve
₹ 4440/-

AI-BL-31
Concealed Stop Cock 15mm
₹ 2670/-

Single Lever Diverter Complete
AI-BL-56 - 40mm (Normal) • ₹ 8020/-
AI-BL-59 - 40mm (Hi-Flow) • ₹ 8575/-
AI-BL-45 - 45mm (Hi-Flow) • ₹ 9355/-

Single Lever Diverter Body & Fitting
AI-BL-DIV01 - 40mm (Normal) • ₹ 3995/-
AI-BL-DIV02 - 40mm (Hi-Flow) • ₹ 4550/-
AI-BL-DIV03 - 45mm (Hi-Flow) • ₹ 5330/-

AI-BL-43
Sink Mixer
₹ 7305/-

AI-BL-EXP-01
S/L Diverter Exposed Parts
₹ 4025/-

AI-BL-64
S/L Wall Mounted Basin Mixer
₹ 10175/-



AI-CG-47
Single Lever Basin Mixer
₹ 6010/-



AI-CG-48
Single Lever Basin Mixer 12" Long
₹ 7330/-



AI-CG-11
Pillar Cock
₹ 2080/-



AI-CG-21
Bib Cock
₹ 1770/-



AI-CG-22
Long Body / Long Nose
₹ 1940/-



AI-CG-16
Pillar Cock 12" Tall
₹ 4110/-



AI-CG-27
Angle Valve
₹ 1705/-



AI-CG-40
Wall Mixer with L-Bend
₹ 8450/-

AI-CG-13
Pillar Cock High Neck
₹ 2445/-

AI-CG-29
2-in-1 Angle Valve
₹ 2670/-

AI-CG-31
Concealed Stop Cock 15mm
₹ 1860/-

Single Lever Diverter Complete
AI-CG-56 - 40mm (Normal) • ₹ 8020/-
AI-CG-59 - 40mm (Hi-Flow) • ₹ 8575/-
AI-CG-45 - 45mm (Hi-Flow) • ₹ 9355/-

Single Lever Diverter Body & Fitting
AI-CG-DIV01 - 40mm (Normal) • ₹ 3995/-
AI-CG-DIV02 - 40mm (Hi-Flow) • ₹ 4550/-
AI-CG-DIV03 - 45mm (Hi-Flow) • ₹ 5330/-

AI-CG-43
Sink Mixer
₹ 5290/-

AI-CG-EXP-01
S/L Diverter Exposed Parts
₹ 4025/-

AI-CG-60
Tipton Spout
₹ 2555/-

AI-CG-61
Plain Spout
₹ 1790/-

AI-CG-41
3-in-1 Mixer with Bend
₹ 8535/-

AI-CG-34
Sink Cock
₹ 2630/-

AI-CG-35
Swan Neck
₹ 3030/-

AI-CG-26
2-in-1 Bib Cock
₹ 2940/-



AI-FG-47
Single Lever Basin Mixer
₹ 7925/-



AI-FG-48
Single Lever Basin Mixer 12" Long
₹ 10055/-



AI-FG-16
Pillar Cock 12" Tall
₹ 6010/-



AI-FG-11
Pillar Cock
₹ 2810/-



AI-FG-21
Bib Cock
₹ 2760/-



AI-FG-22
Long Body / Long Nose
₹ 2920/-



AI-FG-26
2-in-1 Bib Cock
₹ 4440/-



AI-FG-29
2-in-1 Angle Valve
₹ 4440/-



AI-FG-27
Angle Valve
₹ 2235/-



AI-FG-35
Swan Neck
₹ 4385/-



Single Lever Diverter Complete
AI-FG-56 - 40mm (Normal) ₹ 8020/-
AI-FG-59 - 40mm (Hi-Flow) ₹ 8575/-
AI-FG-45 - 45mm (Hi-Flow) ₹ 9355/-



AI-FG-61
Plain Spout
₹ 2865/-



AI-FG-60
Tip Ton Spout
₹ 4440/-



AI-FG-34
Sink Cock
₹ 4010/-



AI-FG-43
Sink Mixer
₹ 7305/-



AI-FG-40
Wall Mixer with L-Bend
₹ 11685/-



AI-FG-41
3-in-1 Wall Mixer with L-Bend
₹ 13250/-

AI-FG-13
Pillar Cock High Neck
₹ 3550/-

Single Lever Diverter Body & Fitting
AI-FG-DIV01 - 40mm (Normal) • ₹ 3995/-
AI-FG-DIV02 - 40mm (Hi-Flow) • ₹ 4550/-
AI-FG-DIV05 - 45mm (Hi-Flow) • ₹ 5330/-

AI-FG-31
Concealed Stop Cock 15mm
₹ 2670/-

AI-FG-EXP-01
S/L Diverter Exposed Parts
₹ 4025/-

AI-FG-64
S/L Wall Mounted Basin Mixer
₹ 10175/-



CP-42
Center Hole Quarter Turn
₹ 3990/-



CP-40
Wall Mixer with L-Bend
₹ 5590/-



CP-41
3-in-1 Wall Mixer with L-Bend
₹ 7245/-



CP-11
Pillar Cock
₹ 1110/-



CP-21
Bib Cock
₹ 1000/-



CP-22
Long Body
₹ 1110/-



CP-26
2-in-1 Bib Cock
₹ 1925/-



CP-27
Angle Valve
₹ 1000/-



CP-29
2-in-1 Angle Valve
₹ 1925/-



CP-20
Nozzle Bib Cock
₹ 1110/-



CP-28
Washing Machine Tap
₹ 1110/-



CP-24
Flush Cock 1" Medium
Forged Body ₹ 1720/-



Concealed Stop Cock
CP-31 - 15mm • ₹ 1555/-
CP-32 - 20mm • ₹ 1590/-



CP-34
Sink Cock (J Spout)
₹ 1840/-



CP-35
Swan Neck (J Spout)
₹ 2145/-



CP-43
Sink Mixer
₹ 4115/-

Note : In this range flange is not provided.



EL-42
Centre Hole Quarter Turn
₹ 3930/-



EL-40
Wall Mixer with L-Bend
₹ 5695/-



EL-41
3-in-1 Wall Mixer with L-Bend
₹ 6910/-



EL-13
Pillar Cock Hi-Neck
₹ 2330/-



EL-11
Pillar Cock
₹ 1400/-



EL-22
Long Nose
₹ 1290/-



EL-27
Angle Valve
₹ 995/-



EL-26
2-in-1 Bib Cock
₹ 2315/-



EL-23
Flush Cock 1" Medium
Forged Body
₹ 1720/-



Concealed Stop Cock
EL-31 - 15mm • ₹ 1645/-
EL-32 - 20mm • ₹ 1680/-



EL-24
Flush Cock 1" Heavy
₹ 2800/-



EL-34
Sink Cock (J Spout)
₹ 2005/-



EL-35
Swan Neck (J Spout)
₹ 2050/-



EL-43
Sink Mixer
₹ 4355/-



EL-44
Wall Mixer Non- Telephonic
₹ 4355/-



EL-16
Pillar Cock 12" Long
₹ 2970/-

EL-29 2 in 1 Angle Valve ₹ 2315/-

EL-21 Bib Cock ₹ 995/-



II-42
Center Hole Quarter Turn
₹ 3995/-



II-40
Wall Mixer with Bend
₹ 6115/-



II-16
Pillar Cock 12" Long
₹ 3000/-



II-11
Pillar Cock
₹ 1680/-



II-21
Bib Cock
₹ 1305/-



II-22
Long Nose
₹ 1605/-



II-26
2-in1 Bib Cock
₹ 2580/-



II-27
Angle Cock
₹ 1305/-



II-29
2-in1 Angle Cock
₹ 2580/-



II-23
Flush Cock 1" Medium
Forged Body
₹ 1720/-



Concealed Stop Cock
(Fitting 15mm)
II-31 - 15mm • ₹ 1610/-
II-32 - 20mm • ₹ 1645/-



Concealed Stop Cock
(Fitting 20mm)
II-12 - 15mm • ₹ 1695/-
II-12A - 20mm • ₹ 1730/-



II-24
Flush Cock 1" Heavy
₹ 2800/-



II-34
Sink Cock (J Spout)
₹ 1960/-



II-35
Swan Neck (J Spout)
₹ 2015/-



II-36
2-in-1 Sink Cock
₹ 3000/-



II-43
Sink Mixer
₹ 4520/-



II-44
Wall Mixer Non-Telephonic
₹ 4220/-



II-41
3-in-1 Wall Mixer with Bend
₹ 7665/-

II-20
Nozzle Bib Cock
₹ 1520/-

II-28
Washing Machine
₹ 1520/-

II-13
Pillar Cock Hi-Neck
₹ 1530/-

II-14
Flush Cock 1" Light Casted Body
₹ 1680/-



EU-42
Center Hole Quarter Turn
₹ 3995/-



EU-40
Wall Mixer with Bend
₹ 6115/-



EU-16
Pillar Cock 12" Long
₹ 3000/-



EU-11
Pillar Cock
₹ 1680/-



EU-21
Bib Cock
₹ 1305/-



EU-22
Long Nose
₹ 1605/-



EU-26
2-in1 Bib Cock
₹ 2580/-



EU-27
Angle Cock
₹ 1305/-



EU-29
2-in1 Angle Cock
₹ 2580/-



Concealed Stop Cock
(Fitting 15mm)
EU-31 - 15mm • ₹ 1610/-
EU-32 - 20mm • ₹ 1645/-



Concealed Stop Cock
(Fitting 20mm)
EU-12 - 15mm • ₹ 1695/-
EU-12A - 20mm • ₹ 1730/-



EU-24
Flush Cock 1" Heavy
₹ 2800/-



EU-34
Sink Cock (J Spout)
₹ 1960/-



EU-35
Swan Neck (J Spout)
₹ 2015/-



EU-36
2-in-1 Sink Cock
₹ 3000/-



EU-43
Sink Mixer
₹ 4520/-



EU-41
3-in-1 Wall Mixer with Bend
₹ 7665/-

EU-44
Non Telephonic
₹ 4220/-

EU-20
Nozzle Bib Cock
₹ 1520/-

EU-28
Washing Machine Tap
₹ 1520/-

EU-13
Pillar Cock Hi-Neck
₹ 1530/-

EU-23
Flush Cock 1" Medium
Forged Body
₹ 1720/-

EU-14
Flush Cock Light Casted Body
₹ 1680/-



CS-42
Center Hole Quarter Turn
₹ 4070/-



CS-35
Swan Neck (J Spout)
₹ 2215/-



CS-903
Sink Cock Extended Spout
₹ 2285/-



CSCWM-930
Concealed Wall Mixer Complete
₹ 7010/-



CS-30
Sink Cock (Casted Spout)
₹ 2340/-



CS-34
Sink Cock (J Spout)
₹ 2005/-



CS-43
Sink Mixer
₹ 4440/-



CS-11
Pillar Cock
₹ 1490/-



CS-21
Bib Cock
₹ 1050/-



CS-22
Long Nose
₹ 1160/-



CS-27
Angle Valve
₹ 1005/-



CS-29
2-in-1 Angle Valve
₹ 2220/-



CS-28
Nozzle Bib Cock
₹ 1175/-



CS-23
Flush Cock 1" Medium
Forged Body
₹ 1720/-



CS-24
Flush Cock 1" Heavy
₹ 2800/-



Concealed Stop Cock
(Fitting 15mm)
CS-31 - 15mm • ₹ 1610/-
CS-32 - 20mm • ₹ 1645/-



CS-26
2-in-1 Bib Cock
₹ 2220/-



CS-20
Washing Machine Tap
₹ 1175/-



CS-902
Sink Cock Extra Big Round
Spout ₹ 2525/-



CS-901
Swan Neck Extra Big Round
Spout ₹ 2740/-



CS-16
Pillar Cock 12" Tall
₹ 2905/-



CS-40
Wall Mixer with L-Bend / Crutch
₹ 5805/-



CS-41
3-in-1 Wall Mixer with L-Bend
₹ 6755/-

Concealed Stop Cock
(Fitting 20mm)
CS-12 - 15mm • ₹ 1695/-
CS-12A - 20mm • ₹ 1730/-

CS-14
Flush Cock 1" Light Casted Body
₹ 1680/-

CS-33
Swan Neck Casted Body
₹ 2590/-

CS-44
Non Telephonic
₹ 4440/-



CR-42
Center Hole Quarter Turn
₹ 3650/-



CR-21
Bib Cock
₹ 920/-



CR-22
Long Nose
₹ 1120/-



CR-26
2-in-1 Bib Cock
₹ 1915/-



CR-27
Angle Valve
₹ 920/-



CR-27P
Angle Valve (Project)
₹ 825/-



CR-29
2-in-1 Angle Valve
₹ 1915/-



CR-11
Pillar Cock
₹ 1125/-



CR-13
Pillar Cock Hi-Neck
₹ 2250/-



CR-28
Washing Machine Tap
₹ 960/-



CR-20
Nozzle Bib Cock
₹ 960/-



Concealed Stop Cock
(Fitting 15mm)
CR-31 - 15mm • ₹ 1440/-
CR-32 - 20mm • ₹ 1475/-



Concealed Stop Cock
(Fitting 20mm)
CR-12 - 15mm • ₹ 1695/-
CR-12A - 20mm • ₹ 1730/-



CR-14
Flush Cock 1" Light
Casted Body
₹ 1680/-



CR-23
Flush Cock 1" Medium
Forged Body
₹ 1720/-



CR-35
Swan Neck (J Spout)
₹ 1825/-



CR-34
Sink Cock (J Spout)
₹ 1665/-



CR-903
Sink Cock Extended Spout
₹ 1940/-



CR-43
Sink Mixer
₹ 3785/-



CR-16
Pillar Cock 12" Tall
₹ 2905/-



CR-902
Sink Cock Extra Big Round
Spout ₹ 2305/-



CR-901
Swan Neck Extra Big Round
Spout ₹ 2420/-



CR-40
Wall Mixer with L-Bend / Crutch
₹ 5450/-



CR-41
3-in-1 Wall Mixer with L-Bend
₹ 6300/-

CR-24
Flush Cock 1" Heavy
₹ 2800/-

CR-44
Non Telephonic
₹ 3785/-



BL-42
Basin Mixer Quarter Turn
₹ 3650/-



BL-61
Plain Spout
₹ 1030/-
Single Lever Diverter Complete
BL-56 - 40mm (Normal) ₹ 5880-
BL-59 - 40mm (Hi-Flow) ₹ 6435/-
BL-45 - 45mm (Hi-Flow) ₹ 7215/-



BL-40
Wall Mixer with L-Bend
₹ 5450/-



BL-41
3-in-1 Wall Mixer with L-Bend
₹ 6300/-



BL-47
Single Lever Basin Mixer
₹ 3775/-



BL-13
Pillar Cock Hi-Neck
₹ 2250/-



BL-11
Pillar Cock Foam Flow
₹ 1255/-



BL-21
Bib Cock / Long Nose
Project | ₹ 960/-



BL-21P
Bib Cock (Project)
₹ 850/-



BL-22
Long Body (Extra Long)
₹ 1095/-



BL-26
2-in-1 Bib Cock
₹ 1915/-



BL-27
Angle Valve
₹ 965/-



BL-27P
Angle Valve Project
₹ 860/-



BL-29
2-in-1 Angle Valve
₹ 1915/-



BL-60
Tip Ton Spout
₹ 1470/-



Concealed Stop Cock
(Fitting 15mm)
BL-31 - 15mm • ₹ 1440/-
BL-32 - 20mm • ₹ 1475/-



Concealed Stop Cock
(Fitting 20mm)
BL-12 - 15mm • ₹ 1695/-
BL-12A - 20mm • ₹ 1730/-



BL-14
Flush Cock 1"
Light Casted Body
₹ 1620/-



BL-35
Swan Neck (J. Spout)
₹ 1825/-



BL-43
Sink Mixer
₹ 3870/-



BL-16
Pillar Cock 12" Tall
₹ 2905/-



BL-901
Swan Neck Extra Big Round Spout
₹ 2420/-



BL-34
Sink Cock (J. Spout)
₹ 1665/-



BL-902
Sink Cock Extra Big Round Spout
₹ 2305/-



BL-903
Sink Cock Extended Spout
₹ 1930/-

BL-23 Flush
Cock 1" Medium Forged
Body ₹ 1620/-

BL-24
Flush Cock 1" Heavy
₹ 2800/-

BL-44
Non Telephonic
₹ 4085/-

BL-47
S/L Basin Mixer
₹ 3775/-

BL-48
S/L Basin Mixer 12"
Long ₹ 5650/-

BL-EXP-01
S/L Diverter Exposed
Parts ₹ 1885/-

Single Lever Diverter Body & Fitting
BL-DIV-01 - 40mm (Normal) • ₹ 3995/-
BL-DIV-02 - 40mm (Hi-Flow) • ₹ 4550/-
BL-DIV-05 - 45mm (Hi-Flow) • ₹ 5330/-



VI-47
Single Lever Basin Mixer
₹ 3840/-



VI-13
Pillar Cock High Neck
₹ 2535/-



VI-11
Pillar Cock
₹ 1995/-



VI-21
Bib Cock
₹ 1470/-



VI-22
Long Nose
₹ 1605/-



VI-26
2-in-1 Bib Cock
₹ 2595/-



VI-27
Angle Valve
₹ 1415/-



VI-24
Flush Cock 1" Heavy
₹ 2800/-



Concealed Stop Cock
(Fitting 20mm)
VI-12 - 15mm • ₹ 1875/-
VI-12A - 20mm • ₹ 1910/-



VI-29
2-in-1 Angle Valve
₹ 2750/-



VI-60
Tip Ton Spout
₹ 1980/-



VI-61
Plain Spout
₹ 1405/-



VICWM-930
Concealed Wall Mixer
Complete • ₹ 7255/-



Single Lever Diverter Complete
VI-56 - 40mm (Normal) ₹ 5880/-
VI-59 - 40mm (Hi-Flow) ₹ 6435/-
VI-45 - 45mm (Hi-Flow) ₹ 7215/-



VI-35
Swan Neck (J Pipe Spout)
₹ 2570/-



VI-34
Sink Cock (J Pipe Spout)
₹ 2340/-



VI-903
Sink Cock Extended Spout
₹ 2650/-



VI-902
Sink Cock Extra Big Round Spout
₹ 3010/-



VI-901
Swan Neck Extra Big Round
Spout ₹ 3255/-



VI-16
Pillar Cock 12" Tall
₹ 3680/-



VI-48
Single Lever Basin Mixer 12" Long
₹ 5650/-



VI-40
Wall Mixer with L-Bend / Crutch
₹ 6660/-



VI-41
3-in-1 Wall Mixer with Bend
₹ 7120/-

VI-14
Flush Cock 1" Casted Body
₹ 1620/-

VI-23 Flush Cock 1"
Medium Forged Body
₹ 1620/-

VI-42
Basin Mixer Quarter Turn
₹ 4260/-

VI-43
Sink Mixer
₹ 4910/-

VI-44
Non-Telephonic
₹ 4910/-

Single Lever Diverter Body & Fitting
VI-DIV01 - 40mm (Normal) • ₹ 3995/-
VI-DIV02 - 40mm (Hi-Flow) • ₹ 4550/-
VI-DIV05 - 45mm (Hi-Flow) • ₹ 5330/-

VI-EXP-01 S/L Diverter Exposed Parts ₹ 1885/-



FN-42
Center Hole Quarter Turn
₹ 3650/-



FN-35
Swan Neck (J Spout)
₹ 1825/-



FN-903
Sink Cock Extended Spout
₹ 1940/-



FN-43
Sink Mixer
₹ 4085/-



FN-906
Sink Mixer with Flexible C Pipe
₹ 4450/-



FN-44
Wall Mixer Non-Telephonic
₹ 4085/-



FN-39
Wall Mixer with Crutch | Bend
₹ 5345/-



FN-11
Pillar Cock
₹ 1265/-



FN-21
Bib Cock
₹ 965/-



FN-22
Long Nose
₹ 1100/-



FN-26
2-in-1 Bib Cock
₹ 1915/-



FN-27
Angle Valve
₹ 965/-



FN-29
2-in-1 Angle Valve
₹ 1915/-



FN-23
Flush Cock 1" Medium
Forged Body
₹ 1620/-



FN-24
Flush Cock 1" Heavy
₹ 2800/-



Concealed Stop Cock
(Fitting 15mm)
FN-31 - 15mm • ₹ 1440/-
FN-32 - 20mm • ₹ 1475/-



FN-61
Plain Spout
₹ 1400/-



S/L Diverter Complete
FN-56 - 40mm (Normal) ₹ 5880/-
FN-59 - 40mm (Hi-Flow) ₹ 6435/-
FN-45 - 45mm (Hi-Flow) ₹ 7215/-



FN-34
Sink Cock (J Spout)
₹ 1665/-



FN-902
Sink Cock Extra Big Round Spout
₹ 2305/-



FN-901
Swan Neck Extra Big Round Spout
₹ 2420/-



FN-16
Pillar Cock 12" Tall
₹ 2905/-



FN-40
Wall Mixer with L-Bend
₹ 5345/-



FN-41
3-in-1 Wall Mixer with L-Bend
₹ 6755/-



CT-16
Pillar Cock 12" Tall
₹ 3000/-



CT-40
Wall Mixer with L-Bend
₹ 6115/-



CT-13
Pillar Cock High Neck
₹ 2340/-



CT-11
Pillar Cock
₹ 1590/-



CT-21
Bib Cock
₹ 1305/-



CT-22
Long Nose
₹ 1395/-



CT-26
2-in-1 Bib Cock
₹ 2495/-



CT-27
Angle Valve
₹ 1305/-



CT-29
2-in-1 Angle Valve
₹ 2495/-



CT-23
Flush Cock 1" Medium
Forged Body ₹ 1620/-



CT-24
Flush Cock 1" Heavy
₹ 2800/-



Concealed Stop Cock
CT-31 - 15mm • ₹ 1740/-
CT-32 - 20mm • ₹ 1780/-



CT-14
Flush Cock 1" Light Casted Body
₹ 1620/-



Single Lever Diverter Complete
CT-56 - 40mm (Normal) ₹ 5880/-
CT-59 - 40mm (Hi-Flow) ₹ 6435/-



CT-34
Sink Cock (J Spout)
₹ 1960/-



CT-35
Swan Neck (J Spout)
₹ 2015/-



CT-43
Sink Mixer
₹ 4485/-



CT-42
Center Hole Quarter Turn
₹ 4115/-



CT-41
3-in-1 Wall Mixer with L-Bend
₹ 7275/-

CT-20
Nozzle Bib Cock
₹ 1445/-

CT-28
Washing Machine Tap
₹ 1445/-

CT-44
Non Telephonic
₹ 6055/-

CT-61
Plain Spout
₹ 1495/-

CT-60
Tipton Spout
₹ 2085/-

CT-EXP-01
S/L Diverter Exposed Parts
₹ 1885/-

Single Lever Diverter Body & Fitting
CT-DIV-01 - 40mm (Normal) ₹ 3995/-
CT-DIV-02 - 40mm (Hi-Flow) ₹ 4550/-



VG-47
Single Lever Center Hole
₹ 3775/-



VG-40
Wall Mixer with L-Bend
₹ 6025/-



VG-48
S/L Basin Mixer 12" Long
₹ 5650/-



VG-13
Pillar Cock High Neck
₹ 2300/-



VG-11
Pillar Cock
₹ 1515/-



VG-21
Bib Cock
₹ 1180/-



VG-22
Long Nose
₹ 1360/-



VG-27
Angle Valve
₹ 1035/-



VG-26
2-in-1 Bib Cock
₹ 2420/-



VG-61
Plain Spout
₹ 1030/-



Concealed Stop Cock
VG-31 - 15mm • ₹ 1520/-
VG-32 - 20mm • ₹ 1645/-



VG-24
Flush Cock 1" Heavy
₹ 2800/-



VG-23
Flush Cock 1" Medium Forged Body
₹ 1620/-



VG-34
Sink Cock (J Spout)
₹ 2005/-



VG-35
Swan Neck (J Spout)
₹ 2045/-



Single Lever Diverter Complete
VG-56 - 40mm (Normal) ₹ 5880/-
VG-59 - 40mm (Hi-Flow) ₹ 6435/-
VG-45 - 45mm (Hi-Flow) ₹ 7215/-



VG-16
Pillar Cock 12" Tall
₹ 2905/-

VG-14 Flush Cock 1" Light Casted Body | ₹ 1620/-
VG-42 Basin Mixer Quarter Turn | ₹ 3930/-

VG-44 Non Telephonic | ₹ 4355/-
VG-60 Tipton Spout | ₹ 1470/-

VG-EXP-01
S/L Diverter Exposed Parts
₹ 1885/-

Single Lever Diverter Body & Fitting
VG-DIV-01 - 40mm (Normal) • ₹ 3995/-
VG-DIV-02 - 40mm (Hi-Flow) • ₹ 4550/-
VG-DIV-03 - 45mm (Hi-Flow) • ₹ 5330/-



AF-47
Single Lever Center Hole
₹ 3775/-



AF-40
Wall Mixer with L-Bend
₹ 6025/-



AF-41
3-in-1 Wall Mixer with L-Bend
₹ 6770/-



AF-11
Pillar Cock
₹ 1515/-



AF-21
Bib Cock
₹ 1180/-



AF-22
Long Nose
₹ 1360/-



AF-26
2-in-1 Bib Cock
₹ 2420/-



AF-27
Angle Valve
₹ 1035/-



AF-29
2-in-1 Angle Valve
₹ 2420/-



Concealed Stop Cock
(Fitting 15mm)
AF-31 - 15mm • ₹ 1520/-
AF-32 - 20mm • ₹ 1645/-



Concealed Stop Cock
(Fitting 20mm)
AF-12 - 15mm • ₹ 1695/-
AF-12A - 20mm • ₹ 1725/-



AF-24
Flush Cock 1" Heavy
₹ 2800/-



AFCWM-930
Concealed Wall Mixer
Complete
₹ 7255/-



AF-30
Sink Cock Casted Spout
₹ 2425/-



AF-34
Sink Cock (J Spout)
₹ 2005/-



AF-35
Swan Neck (J Spout)
₹ 2045/-



AF-43
Sink Mixer
₹ 4355/-



AF-48
S/L Basin Mixer 12" Long
₹ 5650/-

AF-13
Pillar Cock Hi-Neck
₹ 2300/-

AF-16
Pillar Cock 12" Tall
₹ 2905/-

AF-14
Flush Cock 1" Light Casted Body
₹ 1620/-

AF-23
Flush Cock 1" Medium Forged Body
₹ 1620/-

AF-42
Basin Mixer Quarter Turn
₹ 3930/-

AF-44
Non Telephonic
₹ 4355/-



OR-47
Single Lever Basin Mixer
₹ 3775/-



OR-13
Pillar Cock High Neck
₹ 2250/-



OR-11
Pillar Cock
₹ 1255/-



OR-21P
Bib Cock (Project)
₹ 850/-



OR-21
Bib Cock / Long Nose Project
₹ 960/-



OR-22E
(New Extra) Long Nose
₹ 1095/-



OR-26
2-in-1 Bib Cock
₹ 1915/-



OR-27
Angle Valve
₹ 965/-



OR-27P
Angle Valve (Project)
₹ 860/-



OR-29
2-in-1 Angle Valve
₹ 1915/-



OR-20
Nozzle Bib Cock
₹ 960/-



OR-23
Flush Cock 1" Medium Forged Body
₹ 1620/-



Concealed Stop Cock (Fitting 15mm)
OR-31 - 15mm • ₹ 1440/-
OR-32 - 20mm • ₹ 1475/-



Concealed Stop Cock (Fitting 20mm)
OR-12 - 15mm • ₹ 1695/-
OR-12A - 20mm • ₹ 1725/-



OR-14
Flush Cock 1" Light Casted Body ₹ 1620/-



OR-28
Washing Machine Tap
₹ 960/-



OR-35A
Swan Neck (J Pipe Spout)
₹ 1825/-



OR-901
Swan Neck Extra Big Round Spout ₹ 2420/-



OR-34A
Sink Cock (J Pipe Spout)
₹ 1665/-



OR-43
Sink Mixer
₹ 3870/-



OR-902
Sink Cock Extra Big Round Spot
₹ 2305/-



OR-903
Sink Cock Extended Spout
₹ 1930/-



OR-16
Pillar Cock 12" Tall
₹ 2905/-



OR-40
Wall Mixer with L-Bend
₹ 5450/-



OR-41
3-in-1 Wall Mixer with L-Bend
₹ 6300/-



OR-42
Basin Mixer Quarter Turn
₹ 3650/-

OR-904
Pillar Cock Extra Heavy
₹ 1750/-





Robe Hook
(1010)
₹ 415/-



Single Soap Dish
(1003)
₹ 485/-



Tumbler Holder
(1005)
₹ 625/-



Liquid Soap Dispenser
SS-304 Bottle (1008)
₹ 1540/-



Liquid Soap Dispenser
Glass Bottle (1014)
₹ 1040/-



Paper Holder
(1009)
₹ 570/-



Napkin Ring
(1007)
₹ 570/-



Soap Dish With Tumbler Holder
(1006)
₹ 1055/-



Double Soap Dish
(1004)
₹ 900/-



Towel Rod
(1002)
₹ 965/-

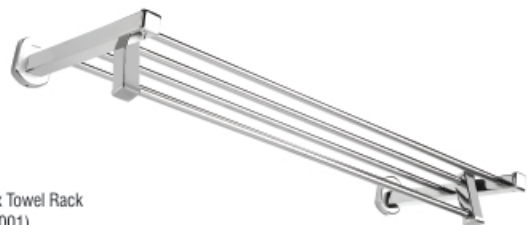

Fix Towel Rack
(1001)
₹ 2140/-



Single Soap Dish
(1103)
₹ 605/-



Robe Hook
(1110)
₹ 605/-



Tumbler Holder
(1105)
₹ 730/-



Liquid Soap Dispenser
(1108)
₹ 1695/-



Paper Holder
(1109)
₹ 865/-



Napkin Ring
(1107)
₹ 865/-



Liquid Soap Dispenser
Glass (1114)
₹ 1250/-



Double Soap Dish
(1104)
₹ 1090/-



LSD Glass & Soap Dish
(1115)
₹ 1660/-



LSD Glass & Tumbler Holder
(1116)
₹ 1830/-



LSD & Tumbler Holder
(1112)
₹ 2245/-



Liquid & Soap Dish
(1111)
₹ 2110/-



Soap Dish with Tumbler Holder
(1106)
₹ 1210/-



Towel Road (24")
(1102)
₹ 1345/-



Fix Towel Rack 24"
(1101)
₹ 4595/-



Single Soap Dish
(1403)
₹ 1125/-



Tumbler Holder
(1405)
₹ 1420/-



Liquid Soap Dispenser
(1408)
₹ 2560/-

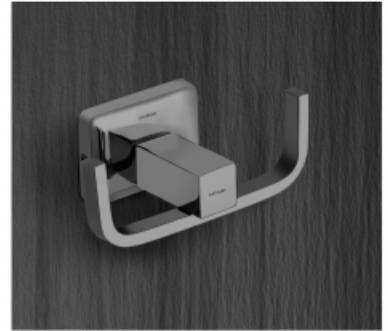

Robe Hook
(1410)
₹ 1005/-



Liquid Soap Dispenser
(1414)
₹ 1905/-



Paper Holder
(1409)
₹ 1485/-



Napkin Ring
(1407)
₹ 1485/-



Double Soap Dish
(1404)
₹ 2110/-



Liquid & Tumbler Holder
(1416)
₹ 3285/-



Liquid & Tumbler Holder
(1412)
₹ 3975/-



LSD & Soap Dish
(1411)
₹ 3695/-



LSD Glass & Soap Dish
(1415)
₹ 3005/-



Soap Dish With Tumbler Holder
(1406)
₹ 2560/-



Towel Rod (24")
(1402)
₹ 2090/-



Fix Towel Rack 24"
(1401)
₹ 7260/-



Single Soap Dish
(1203)
₹ 965/-



Robe Hook
(1210)
₹ 810/-



Tumbler Holder
(1205)
₹ 1225/-



Paper Holder
(1209)
₹ 1195/-



Liquid Soap Dispenser
Glass (1214)
₹ 1710/-



Liquid Soap Dispenser
(1208)
₹ 2365/-

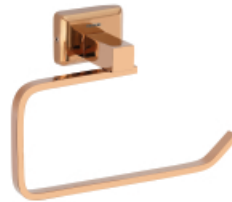

Napkin Ring
(1207)
₹ 1245/-

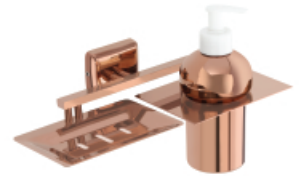

LSD & Soap Dish
(1211)
₹ 3340/-



LSD & Soap Dish
(1215)
₹ 2680/-

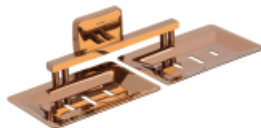

Double Soap Dish
(1204)
₹ 1800/-

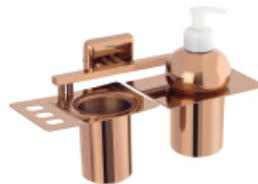

LSD & Tumbler Holder
(1212)
₹ 3645/-



LSD Glass & Tumbler Holder
(1216)
₹ 2990/-

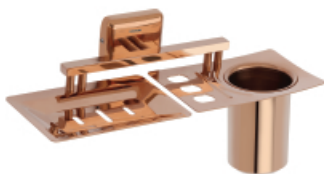

Soap Dish With Tumbler Holder
(1206)
₹ 2195/-



Towel Rod (24")
(1202)
₹ 1905/-



Fix Towel Rack 24"
(1201)
₹ 6395/-



Single Soap Dish
(1303)
₹ 965/-



Robe Hook
(1310)
₹ 810/-



Tumbler Holder
(1305)
₹ 1225/-



Napkin Ring
(1307)
₹ 1250/-



Liquid Soap Dispenser
(1314)
₹ 1710/-



Liquid Soap Dispenser
(1308)
₹ 2365/-



Paper Holder
(1309)
₹ 1250/-



LSD & Soap Dish
(1311)
₹ 3340/-



LSD Glass & Soap Dish
(1315)
₹ 2680/-



Double Soap Dish
(1304)
₹ 1800/-



LSD & Tumbler Holder
(1312)
₹ 3645/-



LSD Glass & Tumbler Holder
(1316)
₹ 2990/-



Soap Dish With Tumbler Holder
(1306)
₹ 2195/-



Towel Rod (24")
(1302)
₹ 1905/-



Fix Towel Rack 24"
(1301)
₹ 6395/-



Single Soap Dish
(4003)
₹ 365/-



Double Soap Dish
(4004)
₹ 655/-



Robe Hook
(4010)
₹ 190/-



Tumbler Holder
(4005)
₹ 445/-



Liquid Soap Dispenser
SS-304 Bottle (4008)
₹ 1250/-



Liquid Soap Dispenser
Glass Bottle (4014)
₹ 730/-



Napkin Ring
(4007)
₹ 315/-



Paper Holder
(4009)
₹ 315/-



Soap Dish With Tumbler Holder
(4006)
₹ 760/-



Towel Rod
(4002)
₹ 500/-



Fix Towel Rack
(4001)
₹ 1935/-

Quadra
Collection



QA-085 | Soap Dish | ₹ 680/-



QA-084
Tumbler Holder
₹ 700/-

QA-086
Towel Ring
₹ 680/-

QA-083
Robe Hook
₹ 450/-

QA-081
Towel Rod
₹ 1010/-

QA-082
Bathroom Set of 5 Items
(includes Soap Dish, Tumbler Holder,
Robe Hook, Towel Ring & Towel Rod)
₹ 3795/-

Doom
Collection



DM-084 | Tumbler Holder | ₹ 755/-

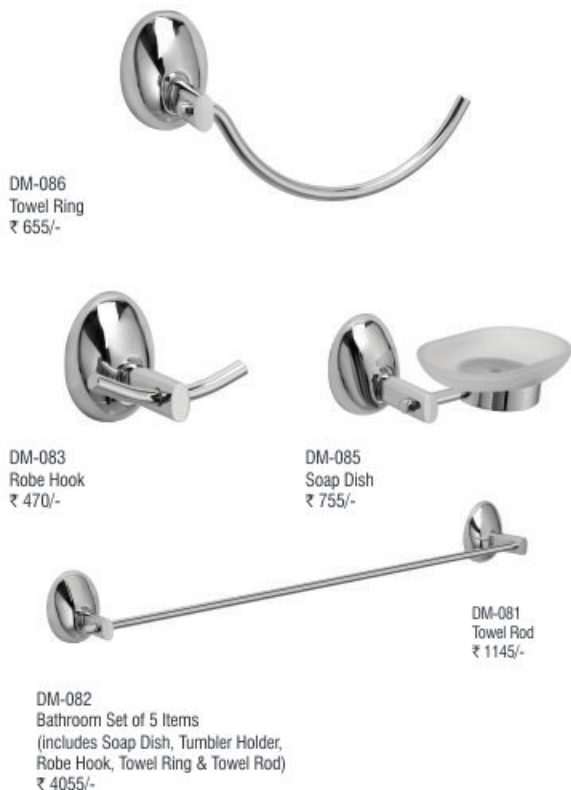

DM-086
Towel Ring
₹ 655/-

DM-083
Robe Hook
₹ 470/-

DM-085
Soap Dish
₹ 755/-

DM-081
Towel Rod
₹ 1145/-

DM-082
Bathroom Set of 5 Items
(includes Soap Dish, Tumbler Holder,
Robe Hook, Towel Ring & Towel Rod)
₹ 4055/-

Towel Rod - Pkg. 4pcs • MOQ - 12 | Towel Ring - Pkg. 4pcs • MOQ - 12 | Soap Dish - Pkg. 4pcs • MOQ - 12
Tumbler Holder - Pkg. 4pcs • MOQ - 12 | Bathroom Sets • MOQ - 6 Sets

Prime
Collection



PE-086 | Towel Ring | ₹ 475/-

Amara
Collection



AA-083 | Robe Hook | ₹ 410/-



PE-084
Tumbler Holder
₹ 500/-

PE-085
Soap Dish
₹ 430/-



PE-083
Robe Hook
₹ 310/-



PE-081
Towel Rod
₹ 700/-

PE-082
Bathroom Set of 5 Items
(includes Soap Dish, Tumbler Holder,
Robe Hook, Towel Ring & Towel Rod)
₹ 2650/-



AA-084
Tumbler Holder
₹ 745/-

AA-086
Towel Ring
₹ 570/-



AA-085
Soap Dish
₹ 755/-



AA-081
Towel Rod
₹ 910/-

AA-082
Bathroom Set of 5 Items
(includes Soap Dish, Tumbler Holder,
Robe Hook, Towel Ring & Towel Rod)
₹ 3535/-

Towel Racks



PETK-121
Towel Rack Prime
₹ 2455/-



CCTK-121
Towel Rack Classic
₹ 3720/-



RYTK-121
Towel Rack Royal
₹ 3950/-

Towel Rods



VC-TR-081
Victoria Towel Rod
with Brass Bracket
₹ 870/-



AD-TR-081
Advent Towel Rod
with Brass Bracket
₹ 870/-



TD-TR-081
Trend Towel Rod
with Brass Bracket
₹ 870/-



BH-TR-081
Brass Hook Towel Rod
₹ 870/-

Towel Ring



VC-TG-086
Victoria Towel Ring
₹ 500/-



TD-TG-086
Trend Towel Ring
with Brass Bracket & SS Ring
₹ 500/-



AD-TG-086
Advent Towel Ring
with Brass Bracket & SS Ring
₹ 500/-



RY-TG-086
Royal Towel Ring
with Brass Bracket & SS Ring
₹ 840/-

SANDWICH Overhead Shower



SHSW-10
10" x 10"
₹ 1825/-



SHSW-08
8" x 8"
₹ 1085/-



SHSW-06
6" x 6"
₹ 775/-



SHSW-04
4" x 4"
₹ 540/-

ULTRA SLIM Overhead Shower



SHUS-12
12" x 12"
₹ 1500/-



SHUS-08
8" x 8"
₹ 860/-

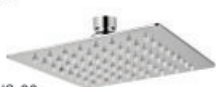

SHUS-06
6" x 6"
₹ 590/-

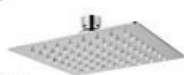

SHUS-04
4" x 4"
₹ 375/-

ELEGANCE Overhead Shower



SHEN-12 - 12" x 12"
₹ 2825/-



SHEN-08 - 8" x 8"
₹ 1325/-



SHEN-06 - 6" x 6"
₹ 885/-



SHEN-04 - 4" x 4"
₹ 570/-

SS 202 KOLLAR Excl. Overhead Shower



SHKO-12 - 12" x 12"
₹ 1955/-



SHKO-08 - 8" x 8"
₹ 1090/-



SHKO-06 - 6" x 6"
₹ 660/-



SHKO-04 - 4" x 4"
₹ 420/-

CURVE S.S. Shower



SHCV-08
8"
₹ 1050/-



SHCV-06
6"
₹ 790/-



SHCV-04
4"
₹ 550/-



OHS-008
6" x 6" with Square Shower
Arm 9" ₹ 935/-



OHS-015
Torch with Arm (Brass)
₹ 1095/-



OHS-019
Exotic
₹ 710/-



OHS-020
Vibro 4"
₹ 780/-



OHS-022
Amaze 5"
₹ 740/-



OHS-023
Vegas 5"
₹ 740/-



OHS-032
Blend
₹ 605/-



OHS-037
Mist 4"
₹ 780/-



OHS-039
Touch
₹ 655/-



OHS-040
Continental 4"
₹ 655/-



OHS-041
Trend
₹ 710/-



OHS-043
Croma
₹ 655/-



OHS-045
Cubix 4" x 4"
₹ 695/-



OHS-046
Alfa 4"
₹ 665/-

































OHS-047
Orno
₹ 710/-



OHS-051
Galaxy 4"
₹ 695/-



OHS-050
Alfa
₹ 695/-

 <p>OHS-052 Vagas ₹ 625/-</p>	 <p>OHS-053 Royal 4" ₹ 615/-</p>	 <p>OHS-054 Elite ₹ 590/-</p>	
 <p>OHSB-009 Neo (300gsm) Brass ₹ 980/-</p>	 <p>OHSB-010 Evoke (350gsm)Brass ₹ 1115/-</p>	 <p>OHSB-011 Axis (200gsm)Brass ₹ 720/-</p>	 <p>OHSB-012 Bell (350gsm) Brass ₹ 1115/-</p>
 <p>OHSB-013 Lexus (500gsm) Brass ₹ 1525/-</p>	 <p>OHSB-24 Czar (500gsm) Brass ₹ 1525/-</p>	 <p>OHSB-25 Craft (200gsm) w/o Arm ₹ 735/-</p>	 <p>OHS-001 Orchid 6" x 6" ₹ 675/-</p>
 <p>OHS-002 Orchid 4" x 4" ₹ 425/-</p>	 <p>OHS-03 Amaze 6" Round ₹ 530/-</p>	 <p>OHS-05 ₹ 270/-</p>	 <p>OHS-06 Vega 6" Round ₹ 530/-</p>
 <p>OHS-07 Angel 6" Round ₹ 530/-</p>	 <p>OHS-044 Cubix 6" x 6" ₹ 550/-</p>	 <p>Platina 6" x 6" ₹ 575/-</p>	 <p>OHS-39 Touch ₹ 730/-</p>
 <p>Pluto (90mm) ₹ 285/-</p>	 <p>Craft 4" x 4" ₹ 255/-</p>	 <p>Electra 4" x 4" ₹ 375/-</p>	 <p>OHS-20 Vibro 4" ₹ 380/-</p>
 <p>OHS-050 Alfa ₹ 365/-</p>	 <p>OHS-23 Vegas 5" ₹ 395/-</p>	 <p>OHS-032 Blend ₹ 260/-</p>	 <p>OHS-52 Vegas ₹ 280/-</p>
 <p>OHS-47 Orno ₹ 365/-</p>	 <p>OHS-40 Continental 4" ₹ 730/-</p>	 <p>OHS-43 Croma ₹ 310/-</p>	 <p>OHS-22 Amaze ₹ 395/-</p>

NOTE : Minimum Order Quantity : 24pcs

PVD SQUARE
Overhead Shower

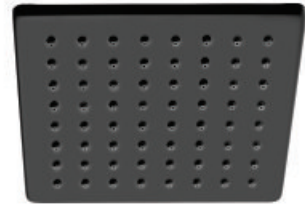
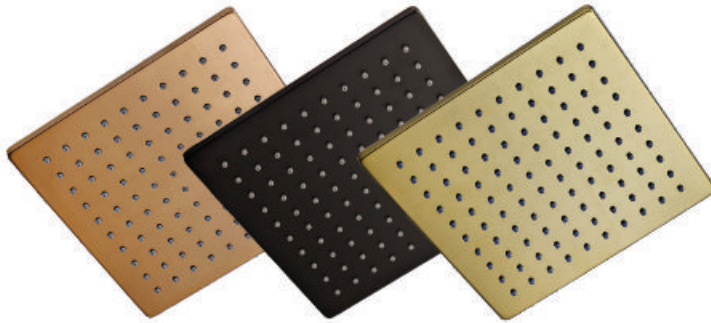

ELEGANCE Square Overhead Shower SH-08

SIZE	Rose Gold RG	Black BG	Gold GL
8 x 8	₹ 2970/-	₹ 2970/-	₹ 2970/-
10 x 10	₹ 5300/-	₹ 5300/-	₹ 5300/-
12 x 12	₹ 6465/-	₹ 6465/-	₹ 6465/-

SMTB-10
8 x 8 - ₹ 2970/-
6 x 6 - ₹ 2545/-

Shower Arm 18" Coloured



Rose Gold - RG-18 - ₹ 1650/-
Black PVD - BL-18 - ₹ 1650/-
Gold - GL-18 - ₹ 1650/-
Matt Black - MATB-18 - ₹ 1650/-

PVD Telephonic Shower

with 1.5 mtr. Heavy SS 304 Tube

TS-FG



Telephonic Shower
& Tube Set Colour
Gold
₹ 2230/-

TS-RG



Telephonic Shower
& Tube Set Colour
Rose Gold
₹ 2230/-

TS-BL



Telephonic Shower
& Tube Set Colour
Matt Black
₹ 2230/-

ABS HEALTH FAUCETS
SET PVD COATED



HFGL 912
₹ 1650/-



HFRG 911
₹ 1650/-

NOTE : Minimum Order Quantity : 24pcs

 <p>HF-01 with SS-202 Tube ₹ 675/-</p> <p>with SS-304 Tube ₹ 780/-</p>	 <p>HF-03 with PVC Tube ₹ 400/-</p>	 <p>HF-17 with SS-202 Tube ₹ 775/-</p> <p>with SS-304 Tube ₹ 880/-</p>	 <p>HF-18 with SS-202 Tube ₹ 715/-</p> <p>with SS-304 Tube ₹ 820/-</p>	 <p>HF-19 with SS-202 Tube ₹ 715/-</p> <p>with SS-304 Tube ₹ 820/-</p>	 <p>HF-20 with PVC Tube ₹ 275/-</p>	
 <p>HF-26 with SS-202 Tube ₹ 775/-</p> <p>with SS-304 Tube ₹ 880/-</p>	 <p>HF-27 with SS-202 Tube ₹ 675/-</p> <p>with SS-304 Tube ₹ 780/-</p>	 <p>HF-28 with SS-202 Tube ₹ 775/-</p> <p>with SS-304 Tube ₹ 880/-</p>	 <p>HF-29 with SS-202 Tube ₹ 775/-</p> <p>with SS-304 Tube ₹ 880/-</p>	 <p>HF-40 with SS-202 Tube ₹ 675/-</p> <p>with SS-304 Tube ₹ 780/-</p>	 <p>HF-42 with SS-202 Tube ₹ 675/-</p> <p>with SS-304 Tube ₹ 780/-</p>	
 <p>HF-53 with SS-202 Tube ₹ 725/-</p> <p>with SS-304 Tube ₹ 830/-</p>	 <p>HF-54 with SS-202 Tube ₹ 835/-</p> <p>with SS-304 Tube ₹ 945/-</p>	 <p>HF-55 with SS-202 Tube ₹ 740/-</p> <p>with SS-304 Tube ₹ 850/-</p>	 <p>HF-56 with SS-202 Tube ₹ 730/-</p> <p>with SS-304 Tube ₹ 840/-</p>	 <p>HF-57 with SS-202 Tube ₹ 740/-</p> <p>with SS-304 Tube ₹ 850/-</p>	 <p>HF-58 with SS-202 Tube ₹ 840/-</p> <p>with SS-304 Tube ₹ 945/-</p>	 <p>HF-59 with SS-202 Tube ₹ 675/-</p> <p>with SS-304 Tube ₹ 780/-</p>

Note : • All Health Faucets are Available with C.P. PVC Tube with 2 Year Warranty
• SS 202 Tube - No Warranty of Rusting • MOQ - 24 Pcs



HFB-05
with SS-202 Tube
₹ 1220/-
with SS-304 Tube
₹ 1280/-



HFB-06
with SS-202 Tube
₹ 1360/-
with SS-304 Tube
₹ 1410/-



HFB-07
with SS-202 Tube
₹ 1360/-
with SS-304 Tube
₹ 1410/-



HFB-08
SS-304 Tube
₹ 1410/-



HFB-09
with SS-202 Tube
₹ 1360/-
with SS-304 Tube
₹ 1410/-

Telephonic Showers

with 1.5 mtr. Heavy SS 304 Tube



TS-5001
₹ 1165/-



TS-5006
₹ 1165/-



TS-5009
₹ 1165/-

Shower Arms



SAR-02
9" SS Shower Arm
₹ 330/-



SAR-03
9" SS Shower Arm (600)
₹ 330/-



SAR-01
Round Shower Arm 9"
₹ 330/-



SASQ-09
Square Shower Arm 9"
₹ 380/-



SASQ-12 ₹ 585/-
SASQ-15 ₹ 690/-
SASQ-18 ₹ 795/-

Bottle Traps (All Brass Body)



BT-01
Bottle Trap PRIME
(SS Pipe - 5" x 12")
₹ 1350/-

BT-02
Bottle Trap ART
(SS Pipe - 5" x 12")
₹ 1630/-

Mouth Operated Taps



FO-003
Sink Cock
₹ 2850/-

FO-001
Bib Cock
₹ 1470/-

FO-002
Long Nose
₹ 1655/-

FO-007
Long Nose (Extra)
₹ 2365/-

Allied PRODUCTS

Pressmatic Taps



PT-11 Pillar Cock
₹ 3265/-



PT-21 Bib Cock
₹ 3265/-



PT-27 Angle Cock
₹ 2960/-



FO-004
Swan Neck 9°
₹ 2385/-



FO-005
Swan Neck 12°
₹ 2690/-



FO-006
Swan Neck 15°
₹ 3030/-

Elbow Action Cocks



AL-101 Pillar Cock
₹ 1865/-



AL-102 Long Nose
₹ 1600/-



AL-103 Bib Cock
₹ 1470/-

Liquid Soap Dispenser



SD-088
Soap Dispenser
₹ 350/-

Teflon Tape



P.T.F.E Thread Seal Tape
₹ 25/-

Tap Cleaner & Shiner



₹ 285/-



NOTE : Minimum Order Quantity : 24pcs

Control Cocks



(25mm)

(40mm)

(15mm)

(20mm)

CC-25
₹ 2325/-

CC-40
₹ 4595/-

CC-15
₹ 1500/-

CC-20
₹ 1910/-

Waste Couplings



WC-01
Brass Waste Coupling
Full Thread / Half Thread 3"
₹ 445/-

WC-02
Brass Popup
Waste Coupling 3"
₹ 850/-

WCRG-05
Brass Popup
Waste Coupling 3"
₹ 1175/-

WCFG-06
Brass Popup
Waste Coupling 3"
₹ 1175/-

WCBL-07
Brass Popup
Waste Coupling 3"
₹ 1175/-

WC-03
S S Waste
Coupling 3"
₹ 230/-

WC-06
Brass Waste
Coupling 6"
₹ 735/-

WC-09
Brass Waste
Coupling 9"
₹ 1090/-

Project Angle Valve (All Brass)



PAV-03
MINI CUBIX
₹ 705/-

PAV-05
MINI FINNS
₹ 485/-

PAV-04
₹ 395/-

PAV-06
₹ 770/-

PAV-07
MINI PRIME ANGLE VALVE
₹ 550/-

PAV-08
MINI TRENDY ANGLE VALVE
₹ 550/-

PAV-09
MINI CLASSIC ARTISTO
ANGLE VALVE
₹ 600/-

CF-27
₹ 510/-

Extension Nipple (All Brass)



EXT-01 - Size 1" - ₹ 100/-
EXT-02 - Size 1 1/2" - ₹ 160/-
EXT-03 - Size 2" - ₹ 205/-
EXT-04 - Size 2 1/2" - ₹ 265/-
EXT-05 - Size 3" - ₹ 315/-

Flush Valve

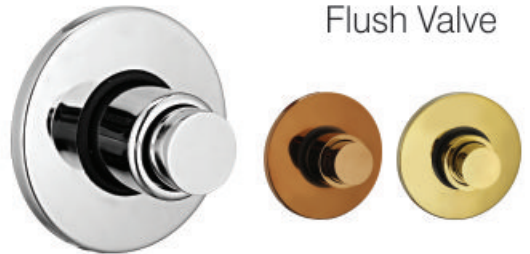

Flush Valve Concealed Type
FV-002 | Size 1" 25mm (Heavy) | ₹ 4825/-
FV-003 | Size 1 1/4" 32mm (Heavy) | ₹ 5450/-
FV-004 | Size 1 1/2" 40mm (Heavy) | ₹ 5900/-
FV-005 | Dual Flush Valve Size 1 1/2" 40mm | ₹ 6200/-

PVD Flush Valve Concealed Type
Rose Gold | FVRG-002 | Size 1" | ₹ 8875/-
Gold | FVFG-003 | Size 1 1/4" | ₹ 9125/-
Black | FVBL-004 | Size 1 1/2" | ₹ 9610/-

Flush Valve Nut & Sleeve ₹ 460/-

Matt Black Flush Valve Concealed Type
FVMATB-002 | Size 1" 25mm | ₹ 7850/-
FVMATB-003 | Size 1 1/4" 32mm | ₹ 8215/-
FVMATB-004 | Size 1 1/2" 40mm | ₹ 8940/-

NEW Concealed Body Parts
of Metropole Flush Valve
FMP-025 | 25mm | ₹ 3550/-
FMP-032 | 32mm | ₹ 3550/-
FMP-040 | 40mm | ₹ 3550/-

NEW UPR-010
Exposed Part Kit 01 Forged
Metropole with Square
Wall Flange & Cartridge
₹ 3900/-



DIV-01
Concealed Single Lever Diverter 40mm Normal Cartridge & Fitting but without exposed parts ₹ 3995/-



DIV-02
Concealed Single Lever Diverter 40mm High Flow Cartridge & Fitting but without exposed parts ₹ 4550/-



DIV-03
Project Range Casted Body Diverter & Fitting (40mm) ₹ 3390/-



DIV-05
Concealed Single Lever Diverter Body 45mm High Flow Cartridge & Fitting but without exposed parts ₹ 5330/-



DIV-06
Concealed Single Lever Diverter Body 45mm 3 inlet Cartridge Fitting but without exposed parts ₹ 6050/-



DIV-07
Single Lever Diverter 2 inlet & 1 outlet ₹ 1305/-



DIV-09
Wall Mounted Basin Mixer Body & Fitting ₹ 3365/-



Wall Mounted Basin Tap Complete
DIV-10 + EXP-10
₹ 1345/- + ₹ 2085/-



DIV-11
New Concealed Mixer Diverter with UNOMIX Cartridge (Complete Set) of Concealed Parts & Exposed Parts ₹ 4095/-



DIV-12
40mm Forged Body Diverter (with Push Type Fitting) ₹ 3730/-



DIV-13
40mm High Flow Forged Body Diverter (with Push Type Fitting) ₹ 4295/-



EXP-01
Diverter Exposed Part (Handle & Plate) (Suitable for DIV-01, DIV-02 & DIV-03) ₹ 1885/-



EXP-05
Diverter Exposed Part (Handle & Plate) (Suitable for DIV-05) ₹ 1885/-



EXP-06
Diverter Exposed Part (Handle & Plate) - 45mm 3 Inlet (Suitable for DIV-06) ₹ 2055/-



EXP-07
Diverter Exposed Part (Handle & Plate) (Suitable for DIV-07) ₹ 1030/-



PR-18
Exposed Parts of Concealed, Light & Medium Flush Cock ₹ 820/-

Flush Cock



FC-15
Flush Cock 1" with Casted Body & Fitting ₹ 810/-



FC-950
Flush Cock 1" with SS Forged Body & Fitting Medium ₹ 810/-

Concealed Stop Cock



Heavy C/S/C with 15mm Fitting
PR-949 (with 15mm Side) ₹ 825/-
PR-950 (with 20mm Side) ₹ 860/-



Concealed Stop Cock with 15mm Fitting
PR-940 (with 15mm Side) ₹ 750/-
PR-941 (with 20mm Side) ₹ 785/-



Concealed Stop Cock with 20mm Fitting
PR-942 (with 15mm Side) ₹ 825/-
PR-943 (with 20mm Side) ₹ 860/-

EXP-09
Exposed Part for Wall Mounted Basin Diverter ₹ 2665/-

DIV-15
45mm Hiflow 3 Outlet Internal Body & Fitting ₹ 5300/-

Note : Introducing DIV-11 New Unomix Cartridge Diverter. Single Cartridge operates for mixing hot & cold water and for diverting water from spout to shower.

Warranty Chart

WARRANTY DURATION (YEARS/MONTHS)

S.NO.	PRODUCT DESCRIPTION	RESIDENTIAL USE	COMMERCIAL USE
1.	CP FAUCET BODY	10	5
2.	PTMT FAUCETS	3	2
3.	PRESSMATIC FAUCET BODY	10	3
4.	PRESSMATIC FAUCETS CARTRIDGE	2	1
5.	SENSOR FAUCETS BODY	3	2
6.	SENSOR FAUCETS / ELECTRONIC PARTS	2	1
7.	ABS OVERHEAD SHOWER / RAIN SHOWER / HAND SHOWER	3	2
8.	304 STAINLESS STEEL / BRASS OVERHEAD SHOWER / RAIN SHOWER / HAND SHOWER	5	3
9.	202 STAINLESS STEEL / BRASS OVERHEAD SHOWER / RAIN SHOWER / HAND SHOWER	1	1
10.	HEALTH FAUCETS - ABS/BRASS	2	1
11.	PROJECT ANGLE VALVES	5	3
12.	ACCESSORIES, FLEXIBLE HOSES, PIPES, HOLDERS	2	1
13.	CONNECTION TUBES	2	1
14.	CONSUMABLE PARTS-AERATORS, BATTERIES, GLASS	2	1
15.	DIVERTER CARTRIDGE	5	3
16.	DISC FITTINGS (BRASS CARTRIDGE)	5	2
17.	304 STAINLESS STEEL BODY CONCEALED DIVERTER FLUSH COCK	10	15

Note : Original / Copy of GST Bill is mandatory for the warranty

32
Year
EDITION
ANNIVERSARY

SCAN ME



FOR CATALOGUE

GOLDLINE[®]

The New Age Bath Fittings

website : www.goldlinebathfittings.com

e-mail : premiumsystems@gmail.com

PREMIUM SYSTEMS

Delhi - 110092 (INDIA)

Registration Trade Mark No. : 714391 B

THINK GRAPHICS # 981107396, 989938313 9

The company reserves the right to alter any part of the contents of this catalogue without further notification to the users.